

U<sub>p</sub>-value of  
up to  
**0.47**  
W/(m<sup>2</sup>·K)



**RC 3 as standard** for all aluminium and stainless steel/aluminium entrance doors

**RC 4 as standard** for ThermoSafe Hybrid entrance doors without glazing



## Entrance Doors

NEW: Stainless steel aluminium entrance doors ThermoPlan Hybrid and ThermoSafe Hybrid

**HÖRMANN**

# Hörmann brand quality impresses in every version

Hörmann aluminium and steel / aluminium entrance doors are superior to plastic or timber doors in many ways. These benefits will convince:

- High thermal insulation
- High security
- High acoustic insulation
- Great stability
- No follow-up painting necessary

Hörmann entrance doors look new even after many years, and also offer you a large variety of options with regard to technical equipment and design. Six entrance door versions from Europe's no. 1 are available for you to choose. Discover your new entrance door!





## CONTENT

- 6 Good reasons to try Hörmann
- 12 Programme overview
- 16 Security equipment
- 18 ThermoCarbon
- 28 ThermoPlan Hybrid ■ **NEW**
- 36 ThermoSafe Hybrid ■ **NEW**, ThermoSafe
- 54 Thermo65
- 64 TopComfort
- 70 Special equipment
- 86 Lock variants ThermoCarbon, ThermoPlan Hybrid, ThermoSafe Hybrid, ThermoSafe
- 95 Hörmann product range

The colours and surface finishes shown are subject to the limitations of the printing process and cannot be regarded as binding.

Some of the products and equipment details described and illustrated in this catalogue are not standard, but available for a surcharge. Descriptions and pictures, information about the scope of delivery, equipment and colour correspond to the time of printing. Subject to changes and errors.

All rights reserved. No part may be reproduced without our prior permission.



## Which entrance door is the right one for us?

An integral feature of every house, the entrance door serves as the signature of your home. But while appearance seems the most crucial aspect, performance is just as essential, including break-in resistance and thermal insulation. Find out here what you need to consider when buying an entrance door.







Timber door



Aluminium entrance door

## The entrance door as the signature of your home

An entrance door needs to fit in with the overall look of the house. Construction materials available today offer a wide range of design possibilities. The most commonly used materials for entrance doors are plastic, aluminium, steel and timber.

## Comparisons of entrance doors

Timber doors require a lot of maintenance to ensure that this natural product can withstand all types of weather, meaning they need constant polishing and painting. However, their very nature provides good insulating properties. And of course, as a natural product, they are environmentally sound.

In contrast, plastic doors are relatively inexpensive and provide good thermal insulation. They are low maintenance, however, they can discolour over time through exposure to light. A steel core is essential to prevent them from becoming warped.

Steel entrance doors are mid-range in terms of price and are very sturdy. **Depending on the design, the material offers good break-in resistance**, while its galvanized and painted surface also resists any type of weather. While somewhat more expensive, aluminium entrance doors also offer **more benefits**. With the right multi-chamber profile, aluminium doors provide **excellent insulation** and also meet stringent safety requirements. **Despite the doors' low weight, they are very sturdy and offer good acoustic insulation**. No more tedious repainting, with a wide range of accessories and equipment.

## Good insulation reduces costs

**When you are deciding on a new entrance door, there is more to consider than just safety, colour or style – insulation is crucial.** Well-insulated doors save money in the long run, because they ensure that valuable heating energy stays indoors, where it belongs. For example, a letter slot in the door introduces draughts into the house and is a common way for heat to escape. Warmth can also be transferred outside through the entrance door when thin materials, insufficient infills and thermally conductive materials are used. The deciding factor is the door's thermal insulation value, also known as the  $U_D$ -value. The smaller this value, the better the thermal insulation. **The energy saving regulation requires that entrance doors have a maximum  $U_D$ -value of  $1.8 \text{ W}/(\text{m}^2 \cdot \text{K})$ .**



Thermographic comparison of a residential building

“A good reputation must be earned.”

August Hörmann

In keeping with the tradition started by the company's founder, the name Hörmann delivers brand name quality with extensive product expertise. The family business has over 80 years of experience as a construction component specialist and sees itself as your partner from the very beginning of building and renovation projects. It's no surprise that Hörmann is one of Europe's most successful entrance door providers. All of this gives you a good feeling when you purchase a Hörmann entrance door.



## 1 Quality products from Germany

The entrance door construction is developed and manufactured by Hörmann. Our highly qualified employees work intensively on new products, continual further developments and improvements to details. Patents and unique products on the market are the result of this. Endurance tests under real conditions **ensure mature series products with Hörmann quality.**

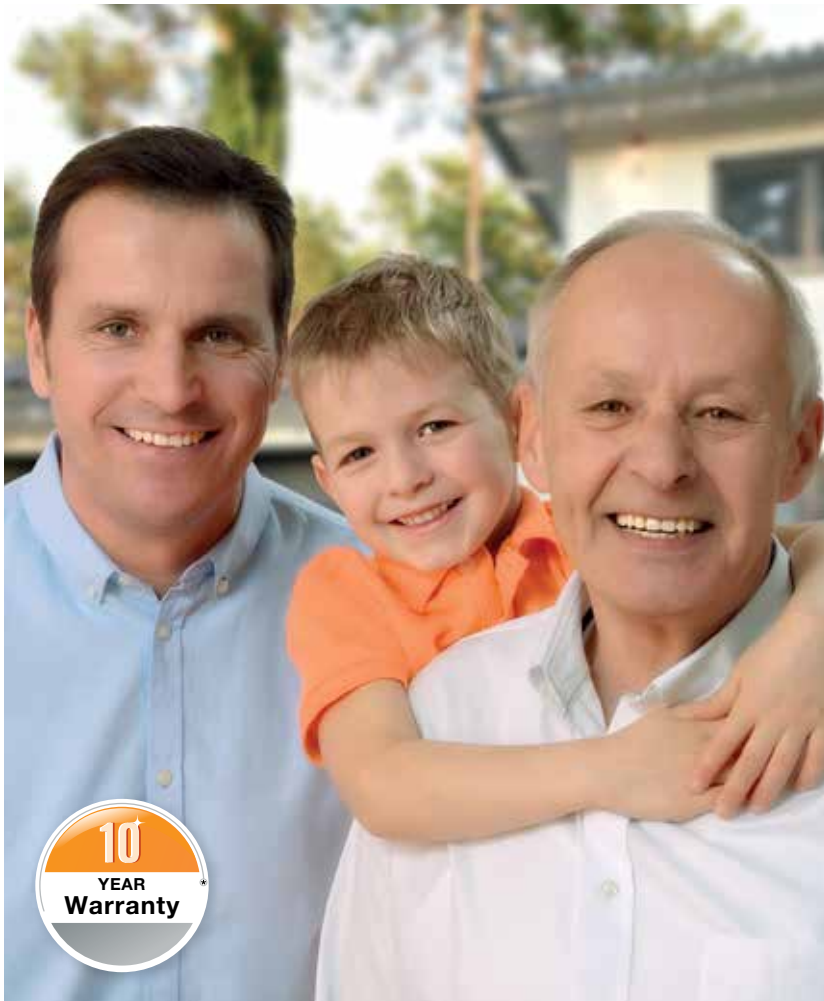

## 2 Entrance doors for generations

We are convinced of our products and our uncompromising quality assurance. That is why we at Hörmann issue a **5-year guarantee\*** on **Thermo65 entrance doors** and even a **10-year guarantee\*** on **ThermoCarbon, ThermoPlan Hybrid, ThermoSafe Hybrid, ThermoSafe and TopComfort entrance doors.**

## 3 An eye on the future

Hörmann is setting a good example. This is why the company obtains **100 % of its energy consumption from green sources.** Together with an intelligent and certified energy management system, CO<sub>2</sub>-neutral mailing and the recycling of valuable materials, more than **40000 tons of CO<sub>2</sub> are saved each year.** And last but not least, Hörmann offers products for sustainable construction.

\* The complete warranty conditions can be found at: [www.hoermann.com](http://www.hoermann.com)





Exterior view



Interior view



## 4 Door leaf without visible leaf profile

Door leaf without visible leaf profile

Our ThermoCarbon, ThermoPlan Hybrid, ThermoSafe Hybrid, ThermoSafe and Thermo65 entrance doors give you an exquisite and elegant reception. The shapely **door leaf with its solid interior and exterior** and leaf profile on the inside fulfils the highest design requirements. The interior view harmonises perfectly with your residential internal doors.

## 5 Flush transition ■ NEW

Flush transition ■ NEW

With the aluminium and stainless steel materials used on the ThermoPlan Hybrid entrance doors, you can enjoy an elegant, flush door view. **You will not be able to see and feel offset between the door leaf and door frame.** Due to the stainless steel sheet on the outside, particularly high leaf rigidity is guaranteed.



External view of entrance doors from other manufacturers with visible leaf profile



Interior view of entrance doors from other manufacturers with visible leaf profile and glazing beads



## 6 Excellent thermal insulation

ThermoCarbon aluminium entrance doors with a  $U_D$ -value of up to approx.  $0.47 \text{ W}/(\text{m}^2\cdot\text{K})^*$

Our doors are the new generation of high-insulation entrance doors. With  $U_D$ -values up to approx.  $0.87 \text{ W}/(\text{m}^2\cdot\text{K})$ , Thermo65 doors have excellent thermal insulation values and the new ThermoPlan Hybrid even has  $U_D$ -values up to approx.  $0.78 \text{ W}/(\text{m}^2\cdot\text{K})$ . ThermoSafe Hybrid and ThermoSafe entrance doors are also distinguished by their  $U_D$ -values of up to approx.  $0.87 \text{ W}/(\text{m}^2\cdot\text{K})$ . All door systems comply with all the requirements of the energy saving regulation. Our ThermoCarbon entrance doors are clearly the **world champions** when it comes to thermal insulation: They feature unparalleled  $U_D$ -values up to  $0.47 \text{ W}/(\text{m}^2\cdot\text{K})$  and are also certified for low-energy houses by the ift Rosenheim.

## 7 Without thermal bridges

**Only from Hörmann** No thermal bridges for glazings

For ThermoCarbon, ThermoPlan Hybrid, ThermoSafe Hybrid and ThermoSafe entrance doors with glazing, the door leaf is foamed together with the glazing and not beforehand, like other door systems. **This patented solution means that we can achieve even better thermal insulation**, as the foam is optimally combined with the glazing to prevent thermal bridges.

\* Dependent on door size. Specified values for RAM 1250 x 2200 mm



**RC 3 as standard** for all aluminium and stainless steel/ aluminium entrance doors  
**RC 4 as standard** for ThermoSafe Hybrid entrance doors without glazing



## 8 Break-in-resistant security equipment

Our entrance doors set new standards for security. All ThermoCarbon, ThermoPlan Hybrid and ThermoSafe entrance doors are available **as standard with the break-in-resistant security class RC 3**. ThermoSafe Hybrid entrance doors without glazing feature security class RC 4 equipment as standard. This security equipment is also available optionally for all ThermoCarbon entrance doors. Thermo65 and TopComfort entrance doors are optionally available with RC 2 equipment. For further information, see pages 16 – 17.

Increased security doesn't mean that the door can't look good. **The break-in-resistant security equipment is not visible on the door**, unlike many competing solutions. That's brand quality from Hörmann!

## 9 Safe glazing

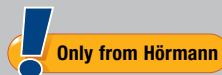

As standard with 8 mm laminated safety glass on the interior and exterior

When it comes to **industrial safety and burglar protection**, Hörmann entrance doors fulfil the absolute highest demands. The laminated safety glass on the interior and exterior of the triple-pane insulated glazing provides **maximum security**. In case of glass breakage, the glass splinters are also bound on the inside, **virtually eliminating any danger of being injured by the shards**. Furthermore, the laminated safety glass offers better protection against burglars as it makes reaching through more difficult.





## 10 Barrier-free entrances

The Hörmann **Ecturn opening aid** makes it **easier for you to open** your ThermoCarbon, ThermoPlan Hybrid, ThermoSafe Hybrid or ThermoSafe entrance door. Due to low energy operation, the opening aid requires no safety devices. **The new HDO 200 door operator opens and closes your TopComfort entrance door fully automatically.** For your security, the Flatscan sensor monitors the inside and outside of the door. Both systems can be conveniently operated with Hörmann BiSecur hand transmitters or radio buttons. For further information, please see page 89.

## 11 Room-high entrance doors

ThermoPlan Hybrid, ThermoSafe Hybrid, ThermoSafe and ThermoCarbon entrance doors in XXL versions offer you **generously proportioned entrance designs** and increased comfort. ThermoPlan Hybrid, ThermoSafe Hybrid and ThermoSafe styles are available up to 2500 mm, ThermoCarbon even up to 3000 mm in height.



Premium class:  
ThermoCarbon



Our thermal insulation world champion for aluminium entrance doors is distinguished by  $U_D$ -values of up to approx.  $0.47 \text{ W}/(\text{m}^2 \cdot \text{K})^*$ . It is also characterised by outstanding **standard RC 3 security equipment** with 9-point locking and a high-tech leaf profile made of carbon glass-fibre hybrid material. See the unique ThermoCarbon entrance doors for yourself, starting on page 18.

Design class:  
ThermoPlan Hybrid

■ NEW



If you value an especially elegant door appearance, the ThermoPlan Hybrid door is your first choice. It impresses with **a flush-fitting transition from door leaf to frame** on interior and exterior. Further advantages are **high leaf rigidity** due to a powder-coated stainless steel sheet. More about this innovation from page 28.

Top class:  
ThermoSafe Hybrid

■ NEW



Especially high thermal insulation thanks to an 80 mm aluminium door frame with thermal break, as standard with a 5-point security lock and **RC 4 for doors without glazing, or RC 3 for doors with glazing**. The ThermoSafe Hybrid impresses with a powder-coated stainless steel sheet and high form stability, even in case of large temperature differences. For further details, please see from page 36.



Exclusive class:  
ThermoSafe



As standard

Especially high thermal insulation thanks to an 80 mm aluminium door frame with thermal break, **standard RC 3 security equipment** with a 5-point security lock and a choice of over 70 styles – these are only a few of the convincing arguments our ThermoSafe entrance door has to offer. For more details and to find your favourite style, see from page 36.

Top class:  
Thermo65



Optional

The Thermo65 entrance door with steel door leaf and aluminium frame offers good thermal insulation values and **high break-in-resistance** with a 5-point security lock. Last but not least, Thermo65 has an excellent price-performance ratio. For more information on Thermo65 and all styles and equipment options, see from page 54.

Comfort category:  
TopComfort



Optional

Are you looking for an **entrance area or office entrance bathed in sunlight** with a glass entrance door that is well equipped in terms of thermal insulation and security? Then our TopComfort entrance door is just right for you. Choose your favourite from 9 glazing designs and a variety of ornamental glazings. For more information on TopComfort, see from page 64.

\* Dependent on door size. Specified values for RAM 1250 × 2200 mm

\*\* Dependent on door size. Specified values for RAM 1230 × 2180 mm

\*\*\*Dependent on door size. Specified values with special equipment thermal insulation kit for RAM 1230 × 2180 mm



## Minimise the risk of break-ins

### Break-in-resistant windows and doors

First of all, secure windows and doors are absolutely essential. Most burglars gain entry to homes through windows and doors that are easy to prise open. For this reason, initiatives such as “Zuhause sicher” (Safe at home) from the German police recommend **adding RC 2 or even RC 3 security equipment to these weak points, depending on the security risk.** An RC 3-approved entrance door, for example, must be able to withstand a break-in attempt for at least five minutes with specific tools. **If a break-in attempt takes longer than 90 seconds, the unwanted guests usually abandon their plans** and try their luck with the next house. Side elements and transom lights should also comply with the resistance class. Don't forget: always lock your door when you leave the house. Most insurance policies do not pay out if the door is unlocked.

### Do not provide any assistance

**It is important to ensure you do not offer potential burglars any assistance** by making your windows easier to access. This includes outdoor tables, chairs or benches that can be used for climbing. Make sure you store these in your house or garage before going away for longer periods.

### Most break-ins occur during the daytime

**It is a fact that the majority of break-ins take place in daylight**, while you are taking your children to school, driving to work or going shopping. Holiday seasons mean the highest risk of break-ins. Burglars look for the smallest changes and signs that you are not at home. **There are a few tips and tricks to ensure you do not tempt burglars**, especially when you are away for longer periods: a well-known recommendation is to inform your neighbours and ask them to collect your post. When the letter box is not cleared regularly, this is an obvious sign that no one is home. In the same way, make sure that your blinds are not shut for the entire time you are away. You can buy different devices that help to simulate your presence at home. For example, there are lights that replicate the flickering of a television and make it look as if someone is at home. Timers that control lights and movement of blinds are also recommended for longer absences. You can also use alarm and video monitoring systems to scare away potential burglars.



Image on right:  
Break-in tools  
according to the RC 3  
security class

About 85 per cent of all burglaries remain unsolved. There are some things you can do to minimise your risk of being burgled.







# We protect you from unwanted visitors

An apartment is broken into every three minutes, making it even more important to equip your entrance door with a high security standard. If a burglar is not successful within approx. 90 seconds, they generally give up their break-in attempt. For this reason, nearly half of all break-in attempts fail if the entrance door is break-in-resistant.

## Optionally for all Thermo65 and TopComfort entrance doors, side elements and transom lights

The opportunist burglar attempts to break open the locked door with simple tools within 3 minutes.



## As standard for all ThermoCarbon, ThermoPlan Hybrid, ThermoSafe Hybrid and ThermoSafe entrance doors, optionally for side elements and transom lights

The burglar attempts to break open the locked door with simple tools, crowbar and simple drilling tools within 5 minutes.



## For ThermoPlan Hybrid entrance doors as standard without glazing and optionally for all ThermoCarbon entrance doors

The experienced burglar attempts to break open the locked door with simple tools, crowbar and simple striking tools within 10 minutes.







## Thermal insulation world champion with premium equipment

Our aim was to create an entrance door that exceeds your requirements for security, thermal insulation, technical equipment and design. We have succeeded with the premium ThermoCarbon entrance door. With  $U_D$ -values of up to approx.  $0.47 \text{ W}/(\text{m}^2 \cdot \text{K})$ , the ThermoCarbon is a deserving thermal insulation world champion and, with the optional RC 4 equipment, is also a frontrunner in terms of security. With its high-tech leaf profile made of carbon glass-fibre hybrid material, our premium entrance door is exceptionally impressive, offering a high degree of rigidity and impact resistance as well as improved acoustic insulation like none other.

The ThermoCarbon entrance door is available in a choice of 20 modern door styles and 19 preferred colours, and optionally in two colours on request. Of course, you can customise your entrance door even further with many other equipment options such as handles, glazings and lock variants.

# Construction

- 1** 100 mm aluminium door leaf with PU rigid foam infill and internal leaf profile
- 2** Thermal break and high stability thanks to carbon glass-fibre reinforced composite leaf profile
- 3** 111 mm aluminium door frame with thermal break
- 4** Triple sealing with two all-round seals

Fulfils all requirements of the energy saving regulation and is certified for low-energy houses by the ift Rosenheim\*

Suitable for fitting without thermal bridges

$U_D$ -value up to approx.  $0.47 \text{ W}/(\text{m}^2 \cdot \text{K})^{**}$

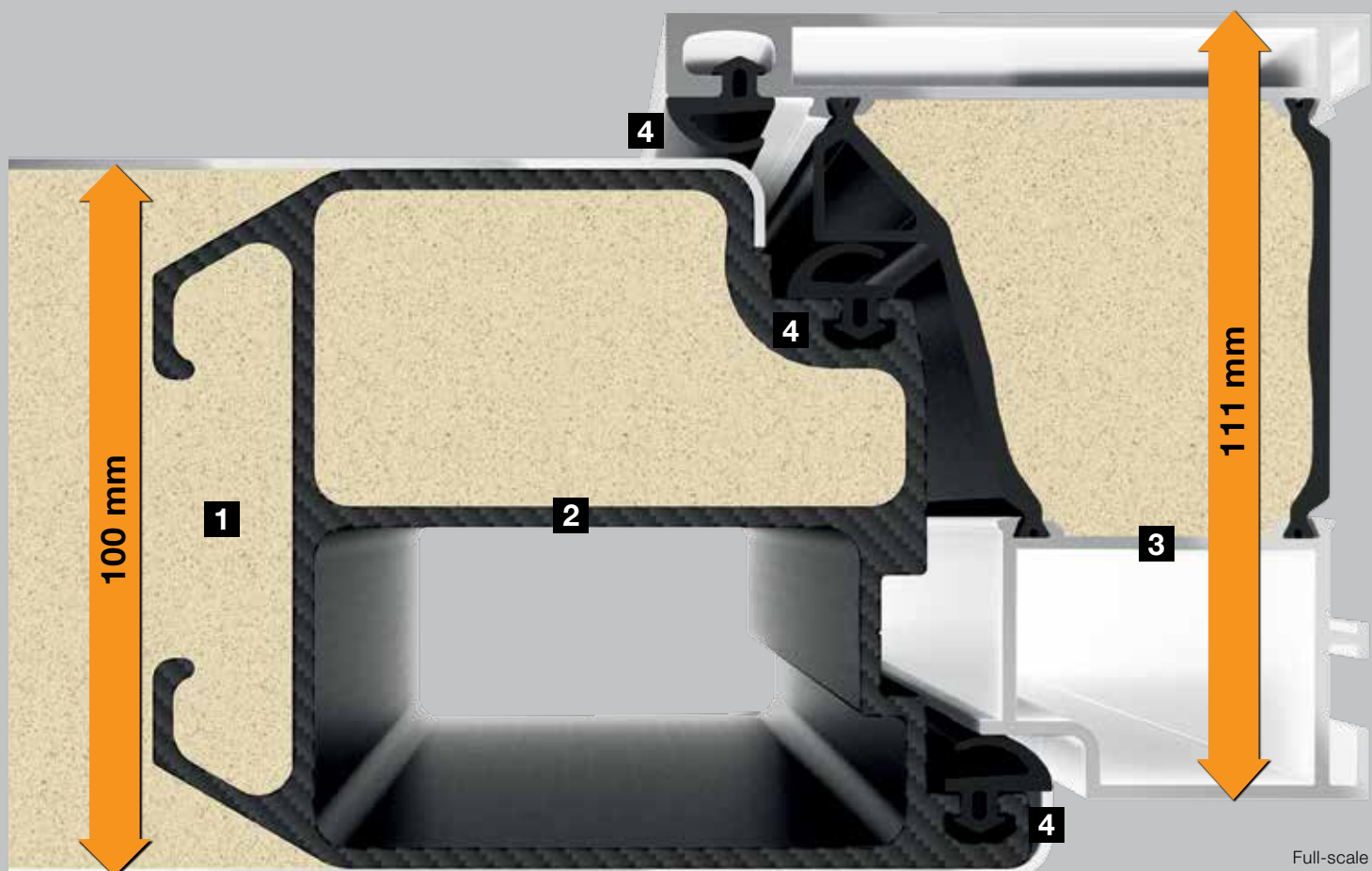
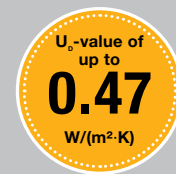

# Equipment

- 5** Solid door view from the inside, as standard in Traffic white RAL 9016, matt, like on internal doors
  - 6** Concealed hinges incl. adjustable opening limiter with soft stop
  - 7** Stainless steel lever handle
  - 8** Quadruple-pane thermal insulation glazing with safety glass on both sides
  - 9** Profile cylinder protected against manipulation
- 
- 10** RC 3 security equipment\*\*\* with 9-point security lock

Optional RC 4 security equipment

# Colour

- As standard in Traffic white, RAL 9016, matt
- Optionally in 19 preferred colours
- Optionally in RAL to choose

For further information, see pages 74 – 75.

# Interior view



\* Not style 310

\*\* Dependent on door size. Specified values for RAM 1250 x 2200 mm

\*\*\*Break-in-resistant components are only effective in preventing burglaries when closed and locked, with the key removed.





**Style 189**  
Preferred colour White aluminium RAL 9006, silk-gloss, stainless steel handle HOE 615, matt float design glass with 7 clear stripes



**Style 300**  
Standard colour Traffic white RAL 9016, matt, handle bar in White aluminium RAL 9006, silk-gloss



**Style 301**  
Preferred colour Anthracite grey RAL 7016, matt, flush-fitting aluminium embellishment and handle bar in White aluminium RAL 9006



**Style 302**  
Preferred colour Stone grey RAL 7030, matt, flush-fitting handle bar in White aluminium RAL 9006, silk-gloss, matt float design glass with a vertical stripe



**Style 304**  
Standard colour Traffic white RAL 9016, matt, recessed grip in White aluminium RAL 9006, silk-gloss, flush-fitting stainless steel handle



**Style 305**  
In Hörmann preferred colour CH 703 Anthracite, fine structure matt, aluminium embellishment in Ruby red RAL 3003, matt, flush-fitting stainless steel handle



**Style 306**  
Standard colour Traffic white RAL 9016, matt, recessed grip in Traffic white RAL 9016, matt, flush-fitting stainless steel handle bar, matt float ornamental glass



**Style 308**  
Standard colour Traffic white RAL 9016, matt, handle bar and recessed grip in Anthracite grey RAL 7016, matt, side elements with matt float ornamental glass



**Style 309**

Preferred colour Slate grey RAL 7015, fine structure matt, flush-fitting handle bar in White aluminium RAL 9006, silk-gloss



**Style 310**

Preferred Hörmann colour CH 607 Chestnut, fine structure matt, flush-fitting stainless steel handle, matt float ornamental glass



**Style 312**

Standard colour Traffic white RAL 9016, matt, flush-fitting handle bar in White aluminium RAL 9006, silk-gloss, matt float design glass with a vertical stripe



**Style 314**

Standard colour Traffic white RAL 9016, matt, recessed grip in Traffic white RAL 9016, matt, flush-fitting stainless steel handle bar, matt float ornamental glass



**Style 504**

Preferred colour Stone grey RAL 7030, fine structure matt, stainless steel handle HOE 500, matt float design glass with 5 clear stripes, side element with matt float ornamental glass



**Style 565**

Standard colour Traffic white RAL 9016, matt, design handle G 760 in Hörmann colour CH 703 Anthracite, fine structure matt



**Style 568**

Preferred Hörmann colour CH 607 Chestnut, fine structure matt, design handle G 750 in anodised aluminium E6 / EV 1



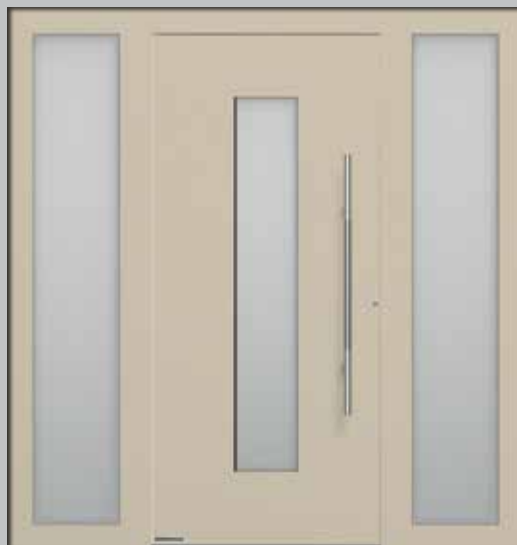

**Style 650**

Preferred colour Cream RAL 9001, fine structure matt, stainless steel handle HOE 700, Pave white ornamental glass



**Style 680**

Standard colour Traffic white RAL 9016, matt, stainless steel handle HOE 700, Pave white ornamental glass



**Style 686**

Standard colour Traffic white RAL 9016, matt, stainless steel handle HOE 600, matt float design glass with 7 clear stripes



**Style 860**

Preferred colour Slate grey RAL 7015, fine structure matt, stainless steel handle HOE 700



**Style 862**

Standard colour Traffic white RAL 9016, matt, stainless steel handle HOE 620



# Premium down to the last detail

## 1 Concealed hinges

The hinges of the ThermoCarbon entrance door are concealed between the door frame and leaf, i.e. they are not visible either from inside or outside: an elegant solution for your home. The door leaf can be simply and easily adjusted by the Hörmann specialist partner. This way, you can close your entrance door comfortably and securely at all times.

## 2 Profile cylinder protected against manipulation

The tamper-proof profile cylinder, certified in accordance with DIN 18252 / DIN EN 1303, impresses with premium fittings: an anti-picking system, which prevents manipulation by objects inserted into the lock, drill-proofing and an emergency and hazard function. This means that the door lock can still be opened when a key is inserted on the inside. 5 reversible keys and 2 key caps are delivered with the door.

## Flush-mounted security rose escutcheon on exterior

The flush-fitting stainless steel security rose escutcheon fits into the door leaf particularly elegantly, and also protects the profile cylinder against being drilled open. Please contact your Hörmann dealer if you wish to use your own cylinder systems.

## 3 Stainless steel interior lever

The elegant Caro stainless steel interior lever is standard for ThermoCarbon entrance doors.

## 4 Stainless steel lock plate

The high-quality stainless steel lock plate is elegantly integrated into the door frame and can be very easily adjusted by the Hörmann specialist partner. This allows for secure locking of the door at all times.

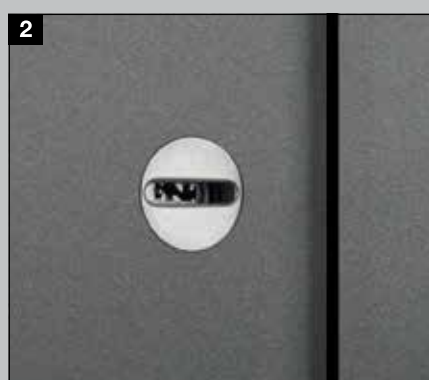

**5 9-point security lock H9 and concealed hinges that cannot be forced open**

The ThermoCarbon is equipped with 9-point security. When locking, 5 steel swing bolts and 4 bolt locks pivot into the stainless steel lock plate. This top security protects your door with just one turn of a key. Doors in XXL version are supplied with the S7 automatic lock with 7-point locking as standard.

## Flush-fitting exterior handles for exclusive door designs

**6 Stainless steel handle with recessed grip**

Doors with a stainless steel handle come as standard with a recessed grip in the colour of the door.

**Custom handle colours**

All flush-fitting exterior handles (except for stainless steel handles) are also available in several colour variants (see pages 84 – 85 for more information).

**7 Continuous aluminium handle bar**

As standard, the complete handle bar is supplied in White aluminium, RAL 9006, silk-gloss, with a recessed grip in the colour of the door.

**8 Aluminium handle bar with recessed grip**

As standard, this handle bar comes in White aluminium, RAL 9006, silk-gloss, with a recessed grip in the colour of the door.





## Elegance for your home

Anyone who has high demands on security, thermal insulation and technical equipment, and also appreciates an exclusive look for their home, will make the right choice with the ThermoPlan Hybrid. The design of this door convinces with the flush transition between the frame and door leaf. The stainless steel sheet on the outside guarantees particularly high form stability, even in case of large temperature differences.

In addition, the high-quality equipment appeals with  $U_D$ -values of up to approx.  $0.78 \text{ W}/(\text{m}^2 \cdot \text{K})$  and with the standard RC 3 equipment.

12 elegant door styles in 19 preferred colours are available for you to choose for ThermoPlan Hybrid entrance doors. With many other equipment options such as handles, glazing and lock variants, the ThermoPlan Hybrid becomes your individual preferred entrance door.





# Construction

- 1 82 mm aluminium door leaf with PU rigid foam infill and internal leaf profile
- 2 High leaf rigidity due to painted exterior stainless steel sheet
- 3 Aluminium leaf profile with thermal break
- 4 82 mm aluminium door frame with thermal break
- 5 Triple sealing with two all-round seals

Fulfils all requirements of the energy saving regulation and is suitable for low-energy houses

Suitable for fitting without thermal bridges

$U_D$ -value up to approx.  $0.78 \text{ W}/(\text{m}^2 \cdot \text{K})^*$

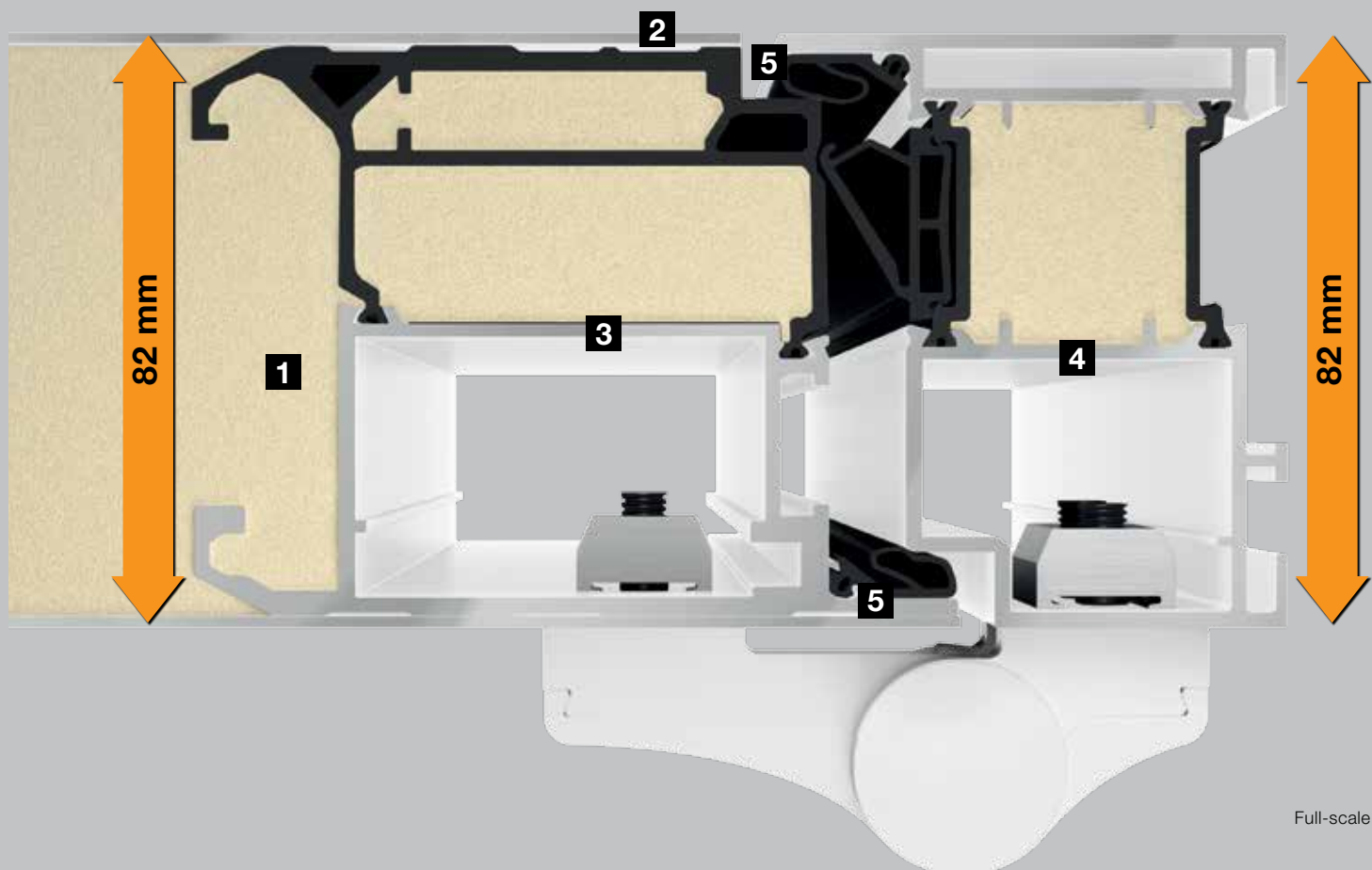
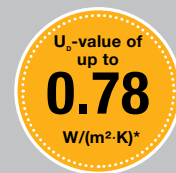

# Equipment

- 6 Solid door view from the inside, as standard in Traffic white RAL 9016, matt, like on internal doors
  - 7 Flush-fitting transition from door leaf to door frame on the outside and inside ■ NEW
  - 8 3-way adjustable hinges
  - 9 Aluminium lever handle
  - 10 Triple-pane thermal insulation glazing with safety glass on both sides
  - 11 Profile cylinder protected against manipulation
- 
- 12 RC 3 security equipment\*\* with 5-point security lock
  - 13 Security bolts
- 

# Colour

- As standard in Traffic white, RAL 9016, matt
- Optionally in 19 preferred colours
- Optionally in RAL to choose

For further information, see pages 74 – 75.

# Interior view



\* Dependent on door size. Specified values for RAM 1230 x 2180 mm

\*\* Break-in-resistant components are only effective in preventing burglaries when closed and locked, with the key removed.



▲ ThermoPlan Hybrid style 189 in preferred Hörmann colour CH 703 Anthracite, fine structure matt, with side elements



**Style 189**  
Preferred colour Light grey RAL 7035, matt, stainless steel handle HOE 615, matt float design glass with 7 clear stripes



**Style 501**  
Standard colour Traffic white RAL 9016, matt, stainless steel handle HOE 500, Satinato glazing



**Style 502**  
Standard colour Traffic white RAL 9016, matt, stainless steel handle HOE 500, Satinato glazing



**Style 503**  
Preferred colour White aluminium RAL 9006, silk-gloss, stainless steel handle HOE 500, matt float design glass with 7 clear stripes



**Style 504**

Standard colour Traffic white RAL 9016, matt, stainless steel handle HOE 500, matt float design glass with 5 clear stripes



**Style 505**

Standard colour Traffic white RAL 9016, matt, stainless steel handle HOE 500, matt float design glass with 4 clear stripes



**Style 686**

Standard colour Traffic white RAL 9016, matt, stainless steel handle HOE 600, stainless steel embellishment, matt float design glass with 7 clear stripes



**Style 860**

Preferred colour Ruby red RAL 3003, matt, stainless steel handle HOE 700



**Style 862**

Standard colour Traffic white RAL 9016, matt, stainless steel handle HOE 620



**Style 867**

Preferred colour Window grey RAL 7040, matt, stainless steel handle HOE 620, matt float design glass with 7 clear stripes



**Style 871**

Standard colour Traffic white RAL 9016, matt, stainless steel handle HOE 620



**Style 872**

Preferred colour Anthracite grey RAL 7016, matt, stainless steel handle HOE 615



# High quality all-round

## 1 3-way adjustable hinges

With the elegant, three-way adjustable hinges, the Hörmann specialist partner can very easily succeed in optimally adjusting the ThermoPlan Hybrid entrance door. This way, your entrance door is optimally sealed and always falls smoothly and securely into its lock.

## Optional concealed hinges (not shown)

Concealed hinges make for an elegant door appearance on the interior. Thanks to hinge leverage protection, security bolts on the hinge side can be omitted.

## 2 Tamper-proof profile cylinder

The anti-picking system prevents manipulation by objects inserted into the lock. The profile cylinder drill-proofing gives you a sense of extra security. The emergency and hazard function is convenient: the door can still be opened and closed when the key is inserted on the inside.

A tamper-proof locking cylinder certified in accordance with DIN 18252 / DIN EN 1303 is supplied including 5 reversible keys and 2 key caps.

## Flush-mounted security rose escutcheon on exterior

The flush-fitting stainless steel security rose escutcheon fits into the door leaf particularly elegantly, and also protects the profile cylinder against being drilled open. Please contact your Hörmann dealer if you wish to use your own cylinder systems.

## 3 Aluminium interior lever

ThermoPlan Hybrid entrance doors are equipped as standard with the attractive Rondo interior lever, stove-enamelled in white. Optionally, it is also available in stainless steel or RAL to choose as well as the versions Caro or Okto, also in stainless steel.

## 4 Stainless steel lock plate

The lock plate is optimally adjusted by the Hörmann specialist partner, so that your door falls shut optimally and can be closed securely.



**5 5-point security lock H5 and security bolts on the hinge side**

When locking, 3 steel swing bolts with 2 additional bolt locks pivot into the stainless steel lock plate. The swing bolts make it more difficult for the door to be pulled apart or forced open.

**6 Electronic spyhole (optional)**

Your entrance area is monitored with a wide angle camera. The spyhole with 3.5" LCD monitor is ideal for small children and persons who depend on a wheelchair.

**Integrated overhead door closer**

(optional, not shown)

The integrated, invisible overhead door closer closes the door and gives your door an elegant interior view – especially in combination with concealed hinges.

**Opening limiter**

(optional, not shown)

The high-quality opening limiter in the metal version restricts the door opening to an opening angle of 105°. It is individually adjustable and features the convenient soft stop function.





## The perfect balance between comfort and security

Our ThermoSafe Hybrid and ThermoSafe entrance doors will convince you with their security and thermal insulation. Thanks to the solid 73 mm thick aluminium door leaf with PU rigid foam infill and an aluminium leaf profile with thermal break on the inside, a  $U_D$ -value up to approx.  $0.87 \text{ W}/(\text{m}^2 \cdot \text{K})$  is achieved. The standard RC 3 security equipment with 5-point security lock on the ThermoSafe gives you a feeling of safety when you go to bed at night.

The new ThermoSafe Hybrid aluminium stainless steel front door impresses with its high dimensional stability, even with large temperature fluctuations inside and outside. The reason: high leaf rigidity due to powder-coated exterior stainless steel sheet. Also in terms of security, this door gives you peace of mind: the RC 4 security equipment is included as standard for styles without glazing, and RC 3 security equipment for styles with glazing.

More than 70 door styles, 19 preferred colours, optional handle variants, glazings and operators are available to choose. The result: your individual dream door!



# Construction

- 1 Solid 73 mm aluminium door leaf with PU rigid foam infill and internal leaf profile
- 2 Aluminium leaf profile with thermal break
- 3 82 mm aluminium door frame with thermal break
- 4 Triple sealing with an all-round seal

Fulfils all requirements of the energy savings regulation

Suitable for fitting without thermal bridges

$U_D$ -value up to approx.  $0.87 \text{ W}/(\text{m}^2 \cdot \text{K})^*$



# ThermoSafe



As standard for ThermoSafe

RC 3 security equipment as standard\*\*

# ThermoSafe Hybrid ■ NEW



- 5 Particularly high leaf rigidity and added security due to exterior stainless steel sheet

RC 4 security equipment\*\* as standard and H5 security lock (styles without glazing)

RC 3 security equipment as standard\*\* (styles with glazing)



As standard for doors without glazing



As standard for doors with glazing

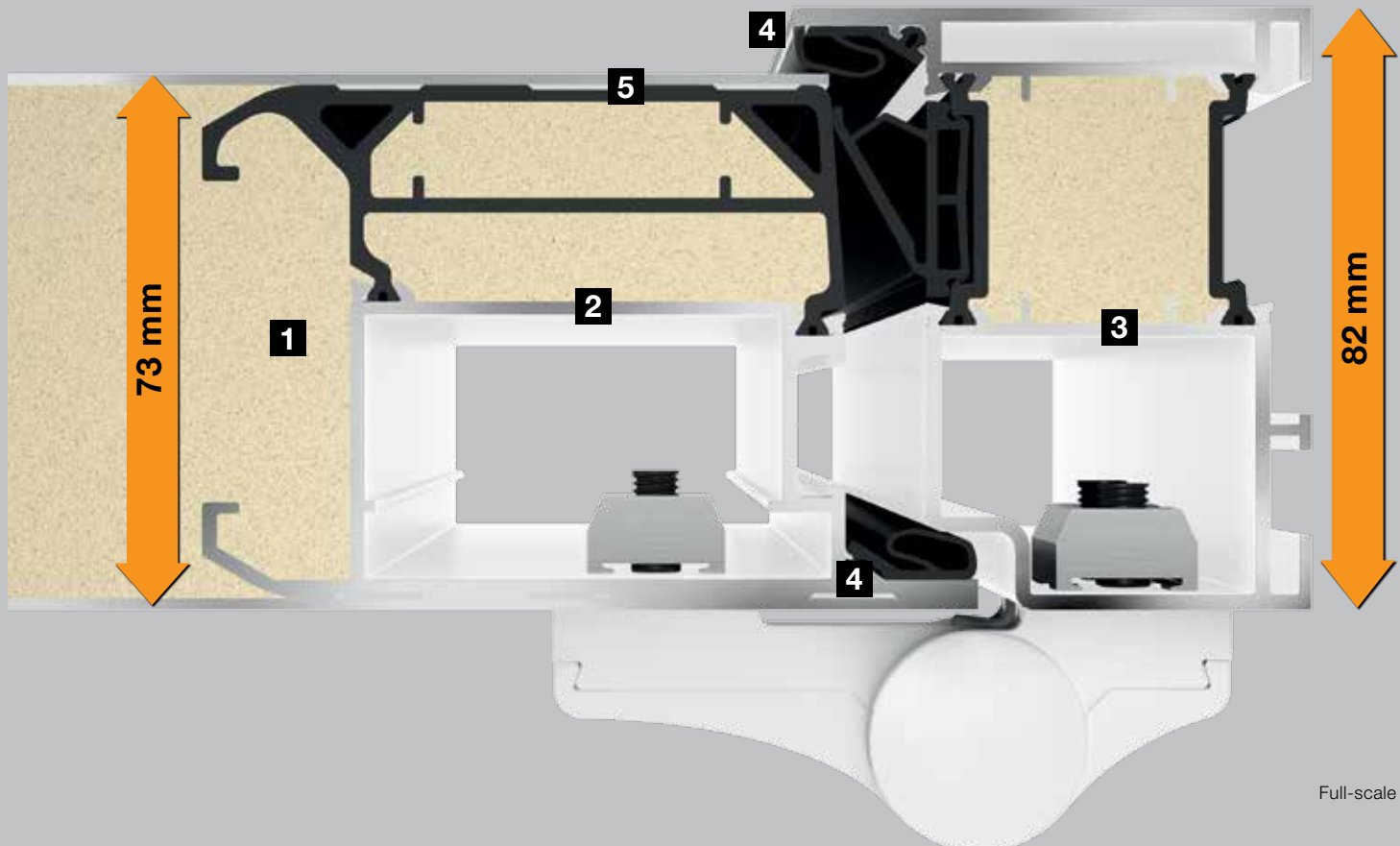

# Equipment

- 6 Solid door view from the inside, as standard in Traffic white RAL 9016, matt, like on internal doors
- 7 Flush-fitting transition from door leaf to door frame on the inside ■ NEW
- 8 3-way adjustable hinges
- 9 Aluminium interior lever
- 10 Triple-pane thermal insulation glazing with safety glass on both sides
- 11 Profile cylinder protected against manipulation
- 12 with 5-point security lock
- 13 Security bolts

# Colour

- As standard in Traffic white, RAL 9016, matt
- Optionally in 19 preferred colours
- Optionally in RAL to choose

For further information, see pages 74 – 75.

# Interior view



\* Dependent on door size. Specified values for RAM 1230 x 2180 mm

\*\* Break-in-resistant components are only effective in preventing burglaries when closed and locked, with the key removed.



**Style 40**  
Preferred colour Stone grey RAL 7030, fine structure matt, stainless steel handle HOE 550, design glass partially matt



**Style 45**  
Standard colour Traffic white RAL 9016, matt, stainless steel handle HOE 200, matt Parsol grey design glass with 4 clear stripes



**Style 65**  
Standard colour Traffic white RAL 9016, matt, stainless steel handle HOE 600, matt float design glass with 7 clear stripes



**Style 75**  
Standard colour Traffic white RAL 9016, matt, stainless steel handle 38-1, Mastercarré ornamental glass stripes



**Style 110**  
Standard colour Traffic white RAL 9016, matt, stainless steel handle 38-1, Pave white ornamental glass



**Style 136**  
Standard colour Traffic white RAL 9016, matt, stainless steel handle 38-1, Satinato design glass with 7 matt stripes



**Style 140**  
Preferred colour Slate grey RAL 7015, matt, stainless steel handle 38-1, stainless steel embellishment, Pave white ornamental glass



**Style 166**  
Preferred colour Hörmann CH 703 Anthracite, fine structure, matt, stainless steel handle 38-1, stainless steel embellishment, Satinato design glass with 7 matt stripes



**Style 176**

Preferred colour White aluminium, RAL 9006, silk-gloss, stainless steel handle HOE 735, Satinato ornamental glass



**Style 177**

Standard colour Traffic white RAL 9016, matt, stainless steel handle HOE 700, Pave white ornamental glass



**Style 185**

Standard colour Traffic white RAL 9016, matt, stainless steel handle 38-2, Mastercarré white ornamental glass



**Style 189**

Standard colour Traffic white RAL 9016, matt, stainless steel handle HOE 615, matt float design glass with 7 clear stripes



**Style 402**

Standard colour Traffic white RAL 9016, matt, stainless steel handle 14-2, Reflo design glass, partially matt with genuine fluted glass



**Style 413**

Standard colour Traffic white RAL 9016, matt, stainless steel handle 14-2, Silk ornamental glass



**Style 449**

Preferred colour Hörmann CH 607 Chestnut, fine structure matt, with style side elements, stainless steel handle 38-1, Reflo design glass with genuine fluted glass squares





**Style 501**  
Preferred colour Quartz grey RAL 7039, fine structure matt, stainless steel handle HOE 500, Satinato glazing



**Style 502**  
Standard colour Traffic white RAL 9016, matt, stainless steel handle HOE 500, Satinato glazing



**Style 503**  
Preferred colour Cream RAL 9001, fine structure matt, stainless steel handle HOE 500, matt float design glass with 7 clear stripes



**Style 504**  
Standard colour Traffic white RAL 9016, matt, stainless steel handle HOE 500, matt float design glass with 5 clear horizontal stripes



**Style 505**  
Preferred colour Light grey RAL 7035, matt, stainless steel handle HOE 500, matt float design glass with 4 clear stripes



**Style 514**  
Standard colour Traffic white RAL 9016, matt, design handle G 750 in White aluminium RAL 9006, silk-gloss, clear float glazing



**Style 515**  
Preferred colour Window grey RAL 7040, matt, design handle G 750 in Anthracite grey RAL 7016, matt, clear float glazing



**Style 524**  
Standard colour Traffic white RAL 9016, matt, design handle G 750 in White aluminium RAL 9006, silk-gloss, clear float glazing



**Style 525**  
Preferred colour Slate grey RAL 7015, matt, design handle G 750 in White aluminium RAL 9006, silk-gloss, clear float glazing



**Style 551**  
Standard colour Traffic white RAL 9016, matt, hand-crafted stainless steel handle HOE 150, with fascia frame Rondo 70



**Style 552**  
Standard colour Traffic white RAL 9016, matt, hand-crafted stainless steel handle HOE 150, matt float design glass with clear stripes and red colour stripes



**Style 553\***  
Standard colour Traffic white RAL 9016, matt, aluminium handle 753 in silver, matt Reflo design glass with genuine fluted glass



**Style 554**  
Standard colour Traffic white RAL 9016, matt, stainless steel handle HOE 730, 553 ornamental glass



**Style 555**  
Preferred colour Hörmann CH 607 Chestnut, fine structure, matt, stainless steel handle HOE 910, Reflo design glass with sandblasted design



**Style 556**  
Preferred colour Anthracite grey RAL 7016, fine structure matt, stainless steel handle HOE 550



**Style 557\***  
Preferred colour White aluminium, RAL 9006, silk-gloss, stainless steel handle HOE 600, with Rondo 70 fascia frame



**Style 558**  
Standard colour Traffic white RAL 9016, matt, stainless steel handle HOE 910, Reflo design glass with genuine horizontal fluted glass



**Style 559**  
Standard colour Traffic white RAL 9016, matt, stainless steel handle HOE 200, design glass matt with 11 clear stripes, with Rondo 70 fascia frame



**Style 560**  
Preferred colour Hörmann CH 703 Anthracite, fine structure, matt, stainless steel handle HOE 600, design glass with 11 matt stripes



**Style 565**  
Preferred colour Hörmann CH 607 Chestnut, fine structure, matt, with handle embellishment in Decograin Golden Oak stripes



**Style 568**  
Preferred colour Hörmann CH 703 Anthracite, fine structure matt, side elements with matt float design glass, design handle G 750, optionally also with integrated light strip in the handle, further information can be found on page 84



**Style 581**  
Standard colour Traffic white RAL 9016, matt, stainless steel handle HOE 600, matt float design glass with clear stripes and red colour stripe



**Style 583**  
Preferred colour Anthracite grey, RAL 7016, matt, colour embellishment in Black brown RAL 8022, matt, aluminium handle G 755, matt Reflo design glass with clear edge



**Style 585**

Standard colour Traffic white RAL 9016, matt, aluminium embellishment in Graphite black RAL 9011, fine structure matt, stainless steel handle HOE 950



**Style 590\***

Preferred colour Slate grey RAL 7015, matt, colour embellishment in Traffic white RAL 9016, matt, design handle G 750, Reflo design glass with genuine fluted glass and sandblasted design, with fascia frame Caro 70



**Style 596**

Preferred colour Light grey RAL 7035, matt, flush-fitting colour embellishment in Anthracite grey RAL 7016, matt, stainless steel handle HOE 735, Satinato ornamental glass



**Style 650**

Preferred colour Window grey RAL 7040, matt, stainless steel handle HOE 700, Pave white ornamental glass



**Style 659**

Preferred colour Stone grey RAL 7030, matt, stainless steel handle 38-2, matt Parsol grey design glass with 7 clear stripes



**Style 667**

Standard colour Traffic white RAL 9016, matt, stainless steel handle HOE 910, matt Parsol grey design glass with 7 clear stripes



**Style 675**

Standard colour Traffic white RAL 9016, matt, with Rondo 70 fascia frame, stainless steel handle 38-1, Reflo design glass with genuine fluted glass and Rondo 70 fascia frame



**Style 680**

Standard colour Traffic white RAL 9016, matt, stainless steel handle HOE 700, Pave white ornamental glass

\* Not available as ThermoSafe Hybrid





▲ **Style 823** in preferred colour Anthracite grey RAL 7016, fine structure matt, optionally with LED spotlight in handle, handle profile in White aluminium RAL 9006, fixing profiles in door colour, with side element



**Style 686**  
Preferred colour Ruby red RAL 3003, matt, stainless steel handle HOE 600, stainless steel embellishment, matt float design glass with 7 clear stripes



**Style 689**  
Standard colour Traffic white RAL 9016, matt, stainless steel handle 38-2, matt Parsol grey design glass with 7 clear stripes



**Style 693**  
White aluminium, RAL 9006, silk-gloss, stainless steel handle HOE 300



**Style 694**  
Preferred colour Terra brown RAL 8028, matt, stainless steel handle HOE 700, Reflo design glass with genuine fluted glass



**Style 697**

Preferred colour Hörmann CH 703 Anthracite, fine structure, matt, with Rondo 70 fascia frame, stainless steel handle HOE 910, Parsol matt grey design glass with 7 clear stripes



**Style 723**

Standard colour Traffic white RAL 9016, matt, handle profile in White aluminium RAL 9006, fixing profiles in door colour, clear float ornamental glass



**Style 757**

Preferred colour Grey aluminium RAL 9007, fine structure matt, stainless steel handle HOE 797, matt float design glass with clear stripes



**Style 759**

Standard colour Traffic white RAL 9016, matt, design handle G 750 in anodised aluminium E6 / EV 1, matt float design glass with clear stripes



**Style 762\***

Preferred colour Stone grey RAL 7030, matt, flush-fitting colour embellishment in the Hörmann colour CH 703 Anthracite, fine structure, matt, stainless steel handle HOE 735, side elements with matt float design glass with 7 clear stripes



**Style 771\***

Standard colour Traffic white RAL 9016, matt, flush-fitting colour embellishment in Anthracite grey RAL 7016, matt, stainless steel handle HOE 735



**Style 777**

Standard colour Traffic white RAL 9016, matt, stainless steel handle HOE 610, matt float ornamental glass

\* Not available as ThermoSafe Hybrid



**Style 779**  
Preferred colour Stone grey RAL 7030, fine structure matt, design handle G 750 in anodised aluminium E6 / EV 1, matt float ornamental glass



**Style 797**  
Preferred colour Anthracite grey RAL 7016, fine structure matt, stainless steel handle HOE 797, matt float ornamental glass



**Style 799**  
Standard colour Traffic white RAL 9016, matt, design handle G 750 in anodised aluminium E6 / EV 1, matt float ornamental glass



**Style 823**  
Standard colour Traffic white RAL 9016, matt, handle profile in White aluminium RAL 9006, fixing profiles in door colour



**Style 832**  
Standard colour Traffic white RAL 9016, matt, stainless steel handle HOE 820, embellishment in Slate grey RAL 7015, with horizontal and vertical stainless steel pilaster strips



**Style 836**  
Standard colour Traffic white RAL 9016, matt, stainless steel handle HOE 820, flush-fitting embellishment in Slate grey RAL 7015



**Style 860**  
Standard colour Traffic white RAL 9016, matt, stainless steel handle HOE 700



**Style 861**  
Standard colour Traffic white RAL 9016, matt, stainless steel handle HOE 700



**Style 862**

Preferred colour Quartz grey RAL 7039, fine structure matt, stainless steel handle HOE 620



**Style 867**

Standard colour Traffic white RAL 9016, matt, stainless steel handle HOE 620, matt float design glass with 7 clear stripes



**Style 871**

Preferred colour Slate grey RAL 7015, fine structure matt, stainless steel handle HOE 620



**Style 872**

Standard colour Traffic white RAL 9016, matt, stainless steel handle HOE 615



**Style 877**

Standard colour Traffic white RAL 9016, matt, stainless steel handle HOE 610, matt float design glass with 3 clear stripes



**Style 878**

Standard colour Traffic white RAL 9016, matt, stainless steel handle HOE 740, flush-fitting stainless steel embellishment



**Style 879**

Standard colour Traffic white RAL 9016, matt, design handle G 750 in anodised aluminium E6 / EV 1, matt float design glass with 3 clear stripes



**Style 891\* ■ NEW**

Preferred colour Quartz grey RAL 7039, fine structure matt, stainless steel handle HOE 820

\* Not available as ThermoSafe Hybrid



# Entrance door and garage door perfectly match each other

The large matching Hörmann programme provides you with aligned entrance door and garage door ribbing options for a matching appearance. The result: no offset from the base line. You will see: the beauty of your home is reflected in these small but crucial details.

## Entrance door styles and sectional garage doors, M or L-ribbed



**ThermoSafe entrance doors:**

Style 825  
Style 845  
Style 855



**Sectional garage doors, M-ribbed:**

with a door height of 2000 mm  
with a door height of 2125 mm  
with a door height of 2250 mm



**ThermoSafe entrance doors:**

Style 875  
Style 895  
Style 898

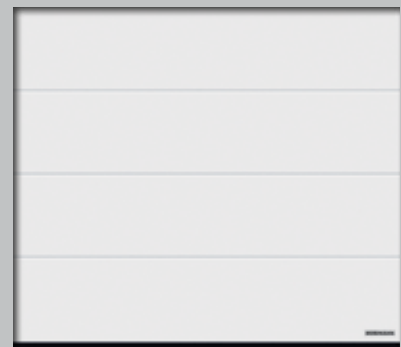

**Sectional garage doors, L-ribbed:**

with a door height of 2000 mm  
with a door height of 2125 mm  
with a door height of 2250 mm

## Matched entrance and garage doors

The cross-section of the entrance and garage door clearly shows the ribbed look of the entrance door is a result of the grooves in the infill. In the garage door, it comes from the ribbing of the individual sections and the section transitions. The aligned appearance applies in the case of a different installation height between the entrance door and garage door. We adjust the groove heights individually according to your specifications, you just have to give us the height offset.

After exact on-site measurement, your Hörmann specialist dealer will offer expert advice in choosing the perfect overall look from these entrance door styles.



ThermoSafe entrance door cross-section

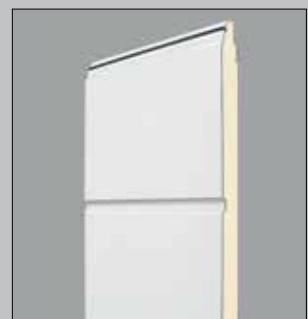

Sectional garage door cross-section



# Matching entrance and garage doors\*



## Style 188

Preferred colour Anthracite grey RAL 7016, stainless steel handle HOE 100, matt float design glass with 3 clear stripes



## Sectional garage door

L-ribbed design style 457 in Silkgrain Anthracite grey RAL 7016



## Style 173

Preferred colour Ruby red RAL 3003, matt, stainless steel handle HOE 300, matt float ornamental glass, side elements with matt float with 3 clear stripes



## Sectional garage door

L-ribbed design style 461 in Silkgrain Ruby red RAL 3003

\* The spacings between entrance and garage doors are not precisely flush

# High quality all-round

## 1 3-way adjustable hinges

With the elegant, three-way adjustable hinges, the door leaf can be simply and conveniently adjusted by the Hörmann specialist partner. This way, your entrance door is optimally sealed and falls smoothly and securely into its lock.

### Optional concealed hinges\* (not shown)

Concealed hinges make for an elegant door appearance on the interior. The hinges are leverage-proof so that the security bolts on the hinge side can be omitted.

## 2 Tamper-proof profile cylinder

The profile cylinder is equipped with an anti-picking system, which prevents manipulation by objects inserted into the lock, and also has drill-proofing. In addition, it offers an emergency and hazard function, i.e. the door can still be opened and closed when a key is inserted on the inside. The tamper-proof locking cylinder is certified according to DIN 18252 / DIN EN 1303 and is delivered with 5 reversible keys and 2 key caps.

### Exterior surface-mounted security rose escutcheon

The patented exterior rose escutcheon also protects the profile cylinder against being drilled open and twisted off. Delivered as standard in Traffic white RAL 9016, or in stainless steel for coloured doors.

## 3 Aluminium interior lever

ThermoSafe Hybrid and ThermoSafe entrance doors are equipped as standard with the attractive Rondo interior lever, stove-enamelled in white. Optionally, it is also available in stainless steel or RAL to choose as well as the versions Caro or Okto, also in stainless steel.

## 4 Stainless steel lock plate

The lock plate is optimally adjusted by the Hörmann specialist partner, so that your door falls shut optimally and can be closed securely.



**5 5-point security lock H5 and security bolts on the hinge side**

When locking, 3 steel swing bolts with 2 additional bolt locks pivot into the stainless steel lock plate. The swing bolts make it more difficult for the door to be pulled apart or forced open.

**6 Electronic spyhole (optional)**

Your entrance area is monitored with a wide angle camera. The spyhole with 3.5" LCD monitor is ideal for small children and persons who depend on a wheelchair.

**Integrated overhead door closer (optional, not shown)**

The integrated overhead door closer closes the door and gives your door an elegant interior view – especially in combination with concealed hinges.

**Opening limiter\***  
(optional, not shown)

The high-quality opening limiter in the metal version restricts the door opening to an opening angle of 105°. It is individually adjustable and features the convenient soft stop function.

**7 Retractable bottom seal with weather protection ■ NEW**

Optional for all ThermoSafe Hybrid and ThermoSafe entrance doors: the retractable bottom seal is the best solution for barrier-free entrances without a threshold. The sealing of the door bottom edge withstands driving rain and convinces with low air permeability.



## Optional frame variants

**8 Broader door frames**

On request, door frames are also available in a width of 110 mm, for a more convenient and attractive connection to full thermal insulation, for example.

**9 Fascia frame Caro 70**

This version has an attractive and distinguished look that upgrades your door through the frame's depth effect.

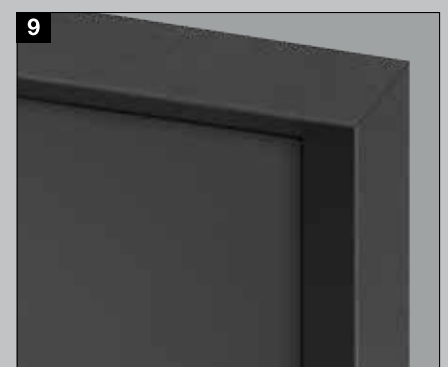
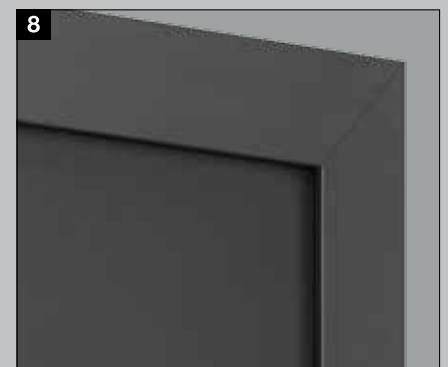

\* For doors opening inwards



## The entrance door that makes you feel welcome

The Thermo65 offers you everything that makes for an excellent entrance door. The solid 65 mm thick steel door leaf with PU rigid foam infill and the leaf profile on the inside made of composite material as well as the aluminium frame with thermal break keep the cold out. With a  $U_D$ -value up to approx.  $0.87 \text{ W}/(\text{m}^2 \cdot \text{K})$ , Thermo65 doors feature good thermal insulation. As standard, the doors are equipped with a 5-point security lock, allowing you to feel safe and secure in your home. Most Thermo65 styles are optionally available with RC 2 security equipment to make you feel even more secure in your own four walls.

Choose your favourite of 14 attractive styles and customise it with one of our 17 preferred colours and 5 Decograin decors.





# Construction

- 1 Solid, 65 mm thick steel door leaf with leaf profile on the inside and thick rebate
- 2 Thermal break and higher stability through the leaf profile made of composite material
- 3 80 mm aluminium frame with thermal break
- 4 Triple sealing

---

Fulfils all requirements of the energy savings regulation

---

Suitable for fitting without thermal bridges

---

**U<sub>D</sub>-value up to approx. 0.87 W/(m<sup>2</sup>·K)\***

---

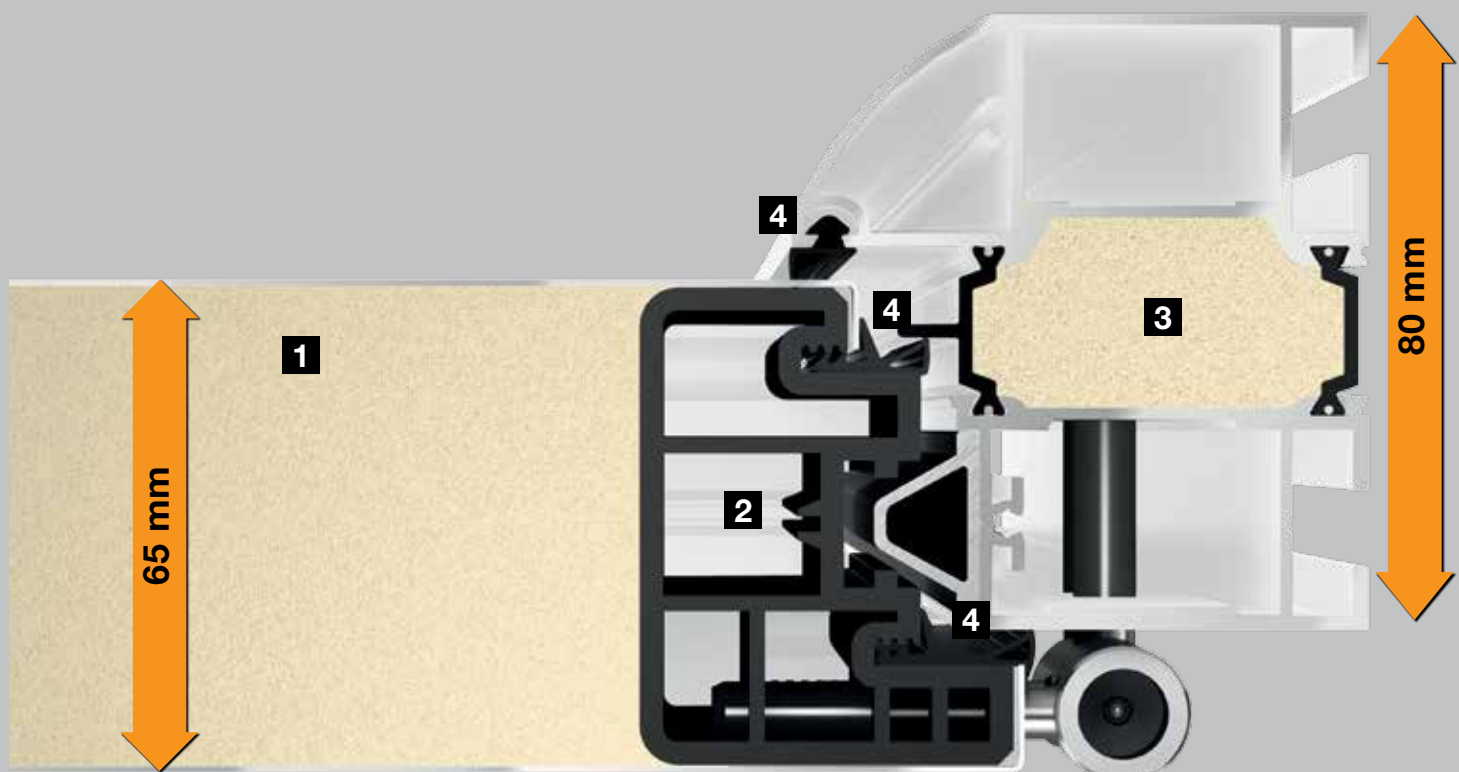
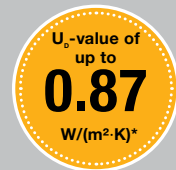

# Equipment

- 5 Solid door view from the inside, same as room doors
- 6 3-way adjustable guide rollers
- 7 Stainless steel interior lever
- 8 Triple-pane insulated glazing
- 9 Profile cylinder with emergency and hazard function
- 10 5-point security lock

---

**Optional RC 2 security equipment\*\***

---

# Colour

- As standard in Traffic white, RAL 9016, matt
- Optional in 17 preferred colours
- Optional in 5 Decograin decors

For further information, see pages 74 – 75.

# Interior view



\* Dependent on door size. Specified values for RAM 1230 x 2180 mm

\*\* Break-in-resistant components are only effective in preventing burglaries when closed and locked, with the key removed.



▲ Thermo65 style 010 in Decograin Titan Metallic CH 703, opening outwards (optional), with side elements



**Style 010**  
Standard colour Traffic white RAL 9016, silk matt, stainless steel handle HB 14-2



**Style 015**  
Decograin Titan Metallic CH 703 with embellishments in stainless steel look, stainless steel handle HB 14-2



**Style 515**  
Standard colour Traffic white RAL 9016, silk matt, stainless steel handle HB 14-2



**Style 600S**  
Standard colour Traffic white RAL 9016, silk matt, stainless steel handle HB 38-3, with surface-mounted Satinato glazing



**Style 700B**

Preferred colour Decograin Titan Metallic CH 703, stainless steel handle HB 38-2, sand-blasted glazing with 7 clear stripes



**Style 750C**

Standard colour Traffic white RAL 9016, silk matt, stainless steel handle HB 38-2, sand-blasted glazing with clear stripes



**Style 800S**

Preferred colour Window grey RAL 7040, silk matt, stainless steel handle HB 38-2, Satinato glazing



**Style 810E**

Standard colour Traffic white RAL 9016, silk matt, stainless steel handle HB 38-2, sand-blasted glazing with clear stripes (square)



**Style 820S**

Decograin Dark Oak, stainless steel handle HB 38-2, Satinato glazing



**Style 850B**

Standard colour Traffic white RAL 9016, silk matt, stainless steel handle HB 38-2, sand-blasted glazing with clear stripes



**Style 900D**

Standard colour Traffic white RAL 9016, silk matt, stainless steel handle HB 38-2, sand-blasted glazing with clear stripes









**Style 100**

Standard colour Traffic white RAL 9016, silk matt, stainless steel handle HB 14-2, side elements with Satinato glazing



**Style 430E**

Standard colour Traffic white RAL 9016, silk matt, stainless steel handle HB 14-2, glazing with clear stripes (frame)



**Style 410S**

Standard colour Traffic white RAL 9016, silk matt, stainless steel handle HB 14-2, Satinato glazing

# Harmony in every detail

## 1 Perfectly hung with 3-way adjustable guide rollers

The sturdy, two-part 3-way adjustable hinges with safety pins and stainless steel decorative covers guarantee smooth door function.

## 2 Securing the hinge side

Being able to rest easy in your own home is important, which is why your Thermo65 door is secured additionally on the hinge side, making it practically impossible to force the door open.

## 3 Interior lever

Each door comes with a beautifully shaped stainless steel interior lever and rose escutcheon on the exterior as standard.

## 4 Profile cylinder

Delivered with 5 keys as standard. With emergency and hazard function, i.e. the door lock can still be operated when the key is inserted on the inside.

## 5 5-point security lock

You will feel safe at home: 2 conical swing bolts engage with 2 additional security bolts and 1 lock bolt in the frame's lock plate and pull the door tightly shut. The lock plate on Thermo65 doors is adjustable for an optimal door setting. With a soft-lock latch to quietly close the door.

## Optional: break-in-resistant security equipment

Depending on your requirements, you can select this increased security for entrance doors, side elements and transom lights with RC 2 features. For further information, please see page 17.

## 6 Frame

The 80 mm aluminium frame with thermal break and PU infill is available in a round-style **6a** or rectangular profile **6b**.

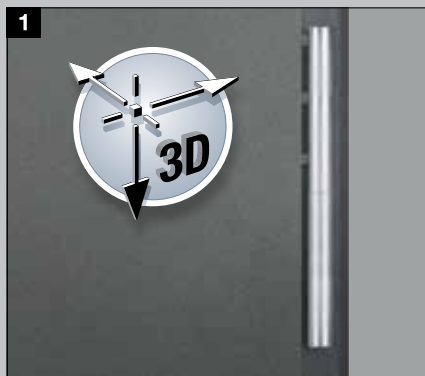

### Automatic lock with mechanical self-locking

When the door falls shut, the bolts automatically extend and securely lock the entrance door.

### Automatic lock with electric motor and opening via BiSecur radio

Open your entrance door easily and conveniently via multiple-point locking using a hand transmitter or radio finger-scan\*. There's no longer any danger of forgetting your keys. Your entrance door automatically unlocks via an electric motor. You can then push the door open.

**7** Hand transmitter HSE 4 BS black textured surface with black plastic caps

**8** Radio finger-scan FFL 12 BS

### **9** Finger-scan integrated in the door leaf ■ NEW

Open your entrance door with your fingerprint! The finger-scan is elegantly integrated in the door leaf and is available for all Thermo65 entrance doors equipped with an automatic lock with electric motor.

### **10** Automatic lock with electric motor and opening via Bluetooth ■ NEW

Opening and closing your door via Bluetooth using your smartphone is even more convenient. Lock and unlock your Thermo65 entrance doors with optional automatic lock with electric motor and opening via Bluetooth using the user-friendly Hörmann BlueSecur app.

### Electric strike (not shown)

With the electric strike catch, you can conveniently open your door via a switch inside the house.

### Reed contact and bolt switch contact (not shown)

For connection to the building technology or alarm system and evaluation that the door is closed (reed contact) or locked (bolt switch contact).

### Door drip (not shown)

Attractive protection: The door drip in Traffic white RAL 9016 or in a stainless steel look diverts driving rain and can also be easily retrofitted.

### Retractable bottom seal (not shown)

This optional equipment is the best solution for sealing entrance doors without threshold rail used for barrier-free entrances.



Standard hand transmitter HSE 4 BS black textured surface with black plastic caps



Door is opened by fingerprint – fitted in the door leaf



Simple operation by smartphone using the Hörmann BlueSecur app

\* Changing fingerprint characteristics in children, adolescents and the elderly can cause malfunctions. For temperature ranges from -20°C to +80°C.





## Glass entrance doors for well-lit entrance areas

Our TopComfort glass entrance doors create a bright and cheerful entrance area with solid equipment. The doors are characterised by an 80 mm thick aluminium door profile and 80 mm aluminium door frame with thermal break and feature good thermal insulation with a  $U_D$ -value up to approx.  $1.3 \text{ W}/(\text{m}^2 \cdot \text{K})$ . The standard 5-point security lock provides the security you expect of an entrance door. This way, you can design an entrance area that is not only tasteful, but also secure.

You can choose between 9 exclusive glass door styles that let in a maximum of natural light. We can supply the frame in one of 19 preferred colours according to your taste. You can personalise the door of your choice with stylish exterior and interior handles and glazings.





# Construction

- 1 Aluminium leaf profile with thermal break, optionally with additional thermal insulation
- 2 80 mm aluminium door frame with thermal break
- 3 Double sealing
- 4 Triple thermal insulation glass with 8 mm safety glass on interior and exterior, optionally as double thermal insulation glass

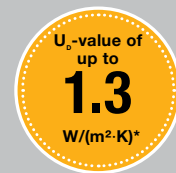

---

Fulfils all requirements of the energy savings regulation

---

Suitable for fitting without thermal bridges

---

**U<sub>D</sub>-value up to approx. 1.3 W/(m<sup>2</sup>·K)\***

---

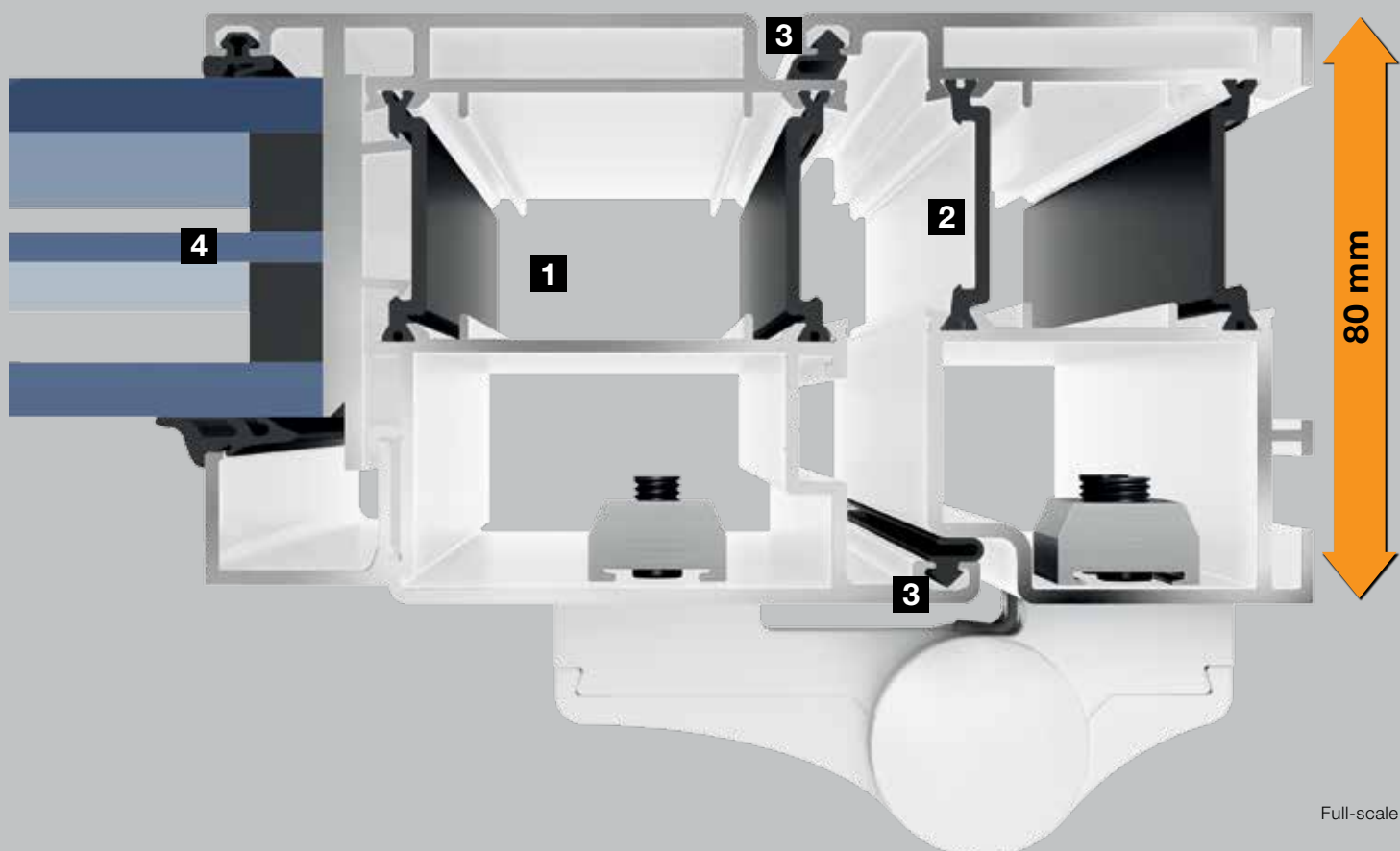

# Equipment

- 5 Square glazing beads, with butt joints
- 6 3-way adjustable hinges
- 7 Aluminium interior lever
- 8 Triple thermal insulation glazing
- 9 Profile cylinder protected against manipulation
- 10 5-point security lock

---

**Optional RC 2 security equipment\*\***

---

# Colour

- As standard in Traffic white, RAL 9016, matt
- Optionally in 19 preferred colours
- Optionally in RAL to choose

For further information, see pages 74 – 75.

# Interior view



\* Dependent on door size. Specified values for RAM 1230 x 2180 mm

\*\* Break-in-resistant components are only effective in preventing burglaries when closed and locked, with the key removed.



▲ TopComfort style 100 / MG 113 in preferred colour Ruby red RAL 3003, matt, with side elements



**Style 100**  
Standard colour Traffic white RAL 9016, matt,  
stainless steel handle 38-1, Mastercarré  
ornamental glass



**Style 101**  
Standard colour Traffic white RAL 9016, matt,  
stainless steel handle 38-1, Mastercarré  
ornamental glass



**Style 100 MG 111**

Preferred colour Hörmann CH 703 Anthracite, fine structure, matt, stainless steel handle 38-2, design glass with matt stripes



**Style 100 MG 112**

Standard colour Traffic white RAL 9016, matt, stainless steel handle 38-2, Micrograin design glass with horizontal structure



**Style 100 MG 113**

Traffic white RAL 9016, matt, stainless steel handle 38-2, design glass with 25 matt stripes

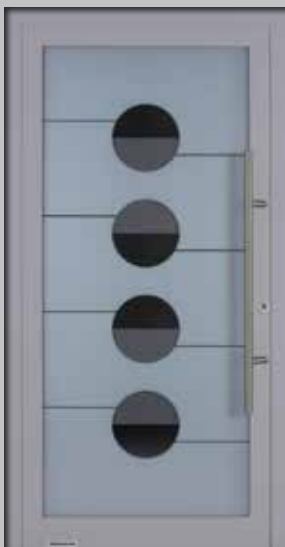

**Style 100 MG 114**

Preferred colour White aluminium RAL 9006, silk-gloss, stainless steel handle 38-2, matt design glass with clear semi-circles and stripes



**Style 100 MG 115**

Standard colour Traffic white RAL 9016, matt, stainless steel handle 38-2, design glass matt with rectangles



**Style 100 MG 116**

Preferred colour Anthracite grey RAL 7016, matt, stainless steel handle 38-2, design glass with matt stripes and crescent

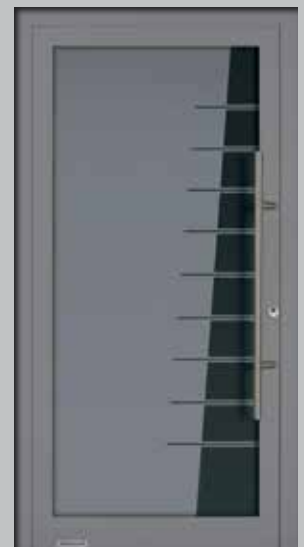

**Style 100 MG 117**

Preferred colour Grey aluminium RAL 9007, fine structure matt, stainless steel handle 38-2, matt design glass with 9 clear stripes





## Doors that make your dreams come true – infuse your home with a sense of well-being

Our optional extras offer you a variety of possibilities to design the door of your dreams according to your individual preferences. For example, you can combine colours, handles and glazings according to your taste. We also offer you a range of security options: You can choose between various automatic locks and convenient operating options that fulfil your needs. Whatever you decide on – at Hörmann, you will find an entrance door to suit both your taste and your home.

## Designing entrances with side elements and transom lights

To create an impressive entrance to your home, you can individually combine each of the illustrated ThermoPlan Hybrid, ThermoSafe Hybrid, ThermoSafe, Thermo65 and TopComfort entrance doors with side elements and transom lights, or combine each ThermoCarbon entrance door with side elements. An elegant and attractive overall look will please you for a long time to come.

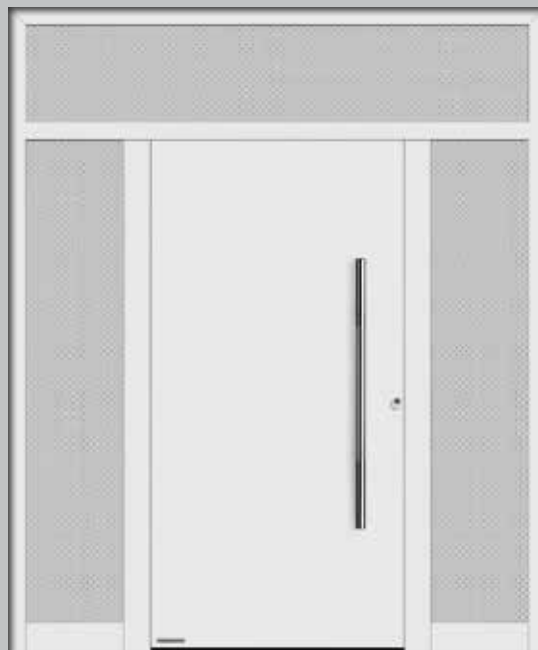

Entrance door with two side elements and transom light



Entrance door with one side element



Entrance door with one side element, style infill in the side element



Entrance door with transom light

The figures show ThermoSafe entrance doors with side elements and transom lights in vertical/horizontal profile construction

# Side elements with practical letter box systems

Hörmann can furnish you with the letter box system to suit your taste and the number of flats. Letter box systems and letter drops are available with bell buttons, light switches and intercom mesh, all with high-grade stainless steel covers and with a thermally insulated aluminium panel infill plate for simple mounting without extensive brickworks.



Classic letter box system for 1 flat



Letter box system RSA 2, insulated, for 5 flats

Door version	ThermoCarbon	ThermoPlan Hybrid	ThermoSafe Hybrid / ThermoSafe	Thermo65	TopComfort
Side elements	●	●	●	●	●
Side elements with style infills		●			
Transom lights		●	●	●	●
Letter box systems		●	●		●

# Find your favourite colour

At Hörmann, we value individuality and variety. That's why we offer entrance doors in the colour of your choice as a matter of course. For example, you can select your favourite colour from the particularly inexpensive Traffic white RAL 9016 and additional preferred colours. Your Hörmann dealer is happy to assist you.



**Please note:**

All colours based on RAL. All colours for ThermoCarbon, ThermoPlan Hybrid, ThermoSafe Hybrid, ThermoSafe and TopComfort are supplied with a matt powder-coating (except RAL 9006, silk-gloss and RAL 9016, high-gloss). All colours for Thermo65 are available in a silk-matt paint coating. Dark colours should not be used for doors that are exposed to the sun.

The colours and surfaces shown are subject to the limitations of the printing process and cannot be regarded as binding. Please consult with your local Hörmann specialised dealer.

Preferred colours

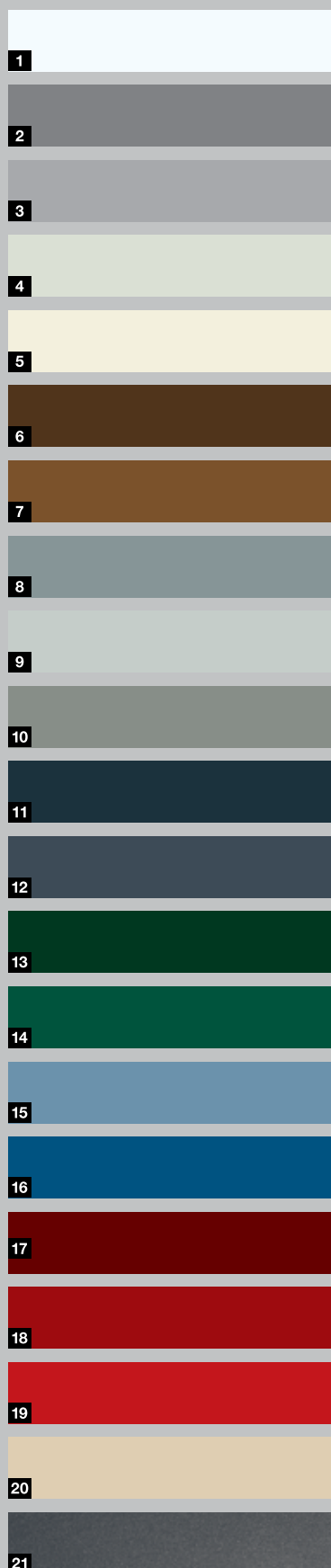

Textured colours



Decograin decors

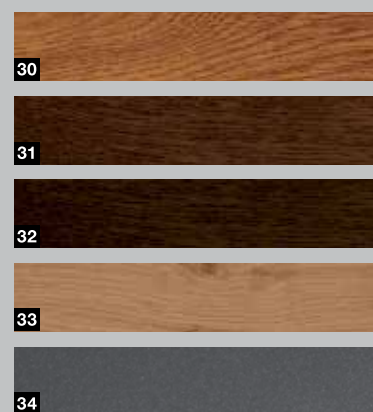

Door versions	ThermoCarbon	ThermoPlan Hybrid	ThermoSafe Hybrid / ThermoSafe	Thermo65	TopComfort
<b>Standard and preferred colours</b>					
RAL 9016 Traffic white (standard)	●	●	●	●	●
1 RAL 9016 Traffic white (high-gloss)	○	○	○		○
2 RAL 9007 Grey aluminium				○	
3 RAL 9006 White aluminium (silk-gloss)	○	○	○	○	○
4 RAL 9002 Grey white				○	
5 RAL 9001 Cream				○	
6 RAL 8028 Terra brown	○	○	○	○	○
7 RAL 8003 Clay brown				○	
8 RAL 7040 Window grey	○	○	○	○	○
9 RAL 7035 Light grey	○	○	○	○	○
10 RAL 7030 Stone grey	○	○	○		○
11 RAL 7016 Anthracite grey	○	○	○	○	○
12 RAL 7015 Slate grey	○	○	○		○
13 RAL 6009 Fir green	○	○	○		○
14 RAL 6005 Moss green	○	○	○	○	○
15 RAL 5014 Pigeon blue				○	
16 RAL 5010 Gentian blue				○	
17 RAL 3004 Purple red				○	
18 RAL 3003 Ruby red	○	○	○	○	○
19 RAL 3000 Flame red				○	
20 RAL 1015 Light ivory				○	
21 CH 703 Anthracite metallic				○	
RAL to choose	○	○	○		○
<b>Textured colours</b>					
22 RAL 9007 Grey aluminium, fine structure matt	○	○	○		○
23 RAL 9001 Cream, fine structure matt	○	○	○		○
24 RAL 7039 Quartz grey, fine structure matt	○	○	○		○
25 RAL 7030 Stone grey, fine structure matt	○	○	○		○
26 RAL 7016 Anthracite grey, fine structure matt	○	○	○		○
27 RAL 7015 Slate grey, fine structure matt	○	○	○		○
28 Hörmann colour CH 703 Anthracite, fine structure matt	○	○	○		○
29 Hörmann colour CH 607 Chestnut, fine structure matt	○	○	○		○
<b>Decograin decors</b>					
30 Golden Oak: medium brown, golden yellow oak design				○	
31 Dark Oak: walnut-coloured oak decor				○	
32 Night Oak: dark, intense oak design				○	
33 Winchester Oak: natural-coloured knotty oak design				○	
34 Titan Metallic CH 703: Anthracite with a metallic effect				○	
<b>Door views</b>					
Outside view in door colour, inside view in Traffic white RAL 9016	●	●	●	○*	●
Outside and inside view in the same door colour	○	○	○	●	○
Outside and inside view in different door colours	○	○	○		○

● = as standard ○ = optional \*(only for Decograin Golden Oak, Dark Oak and Titan Metallic CH 703 with frame A3, opening inwards)



## Custom glazings for side elements and transom lights

Each glass type has a different look depending on colour, structure and finish. That's why Hörmann offers you a wide range of glazings to equip your new entrance door with.

You can match side elements and transom lights to your entrance door according to your wishes with custom glazings or design glass.

Door version	ThermoCarbon	ThermoPlan Hybrid	ThermoSafe Hybrid / ThermoSafe	Thermo65	TopComfort
1 Float, clear/clear glass	●	●	●	●	●
2 Float, matt/sand-blasted	●	●	●	●	●
3 Satinato	●	●	●	●	●
4 Pave white	●	●	●		●
5 Parsol grey	●	●	●		●
6 Parsol grey, matt	●	●	●		●
7 Ornament 504	●	●	●		●
8 Ornament 553	●	●	●		●
9 Chinchilla	●	●	●		●
10 Micrograin (Madras basic)	●	●	●		●
11 Reflo, clear	●	●	●		●
12 Reflo, matt	●	●	●		●
13 Silk	●	●	●		●
14 Mastercarré	●	●	●		●



## Tangibly beautiful design

Each Hörmann entrance door is delivered as standard with the handle shown in the product photos. However, on request, you can equip many of our doors with a customised handle.

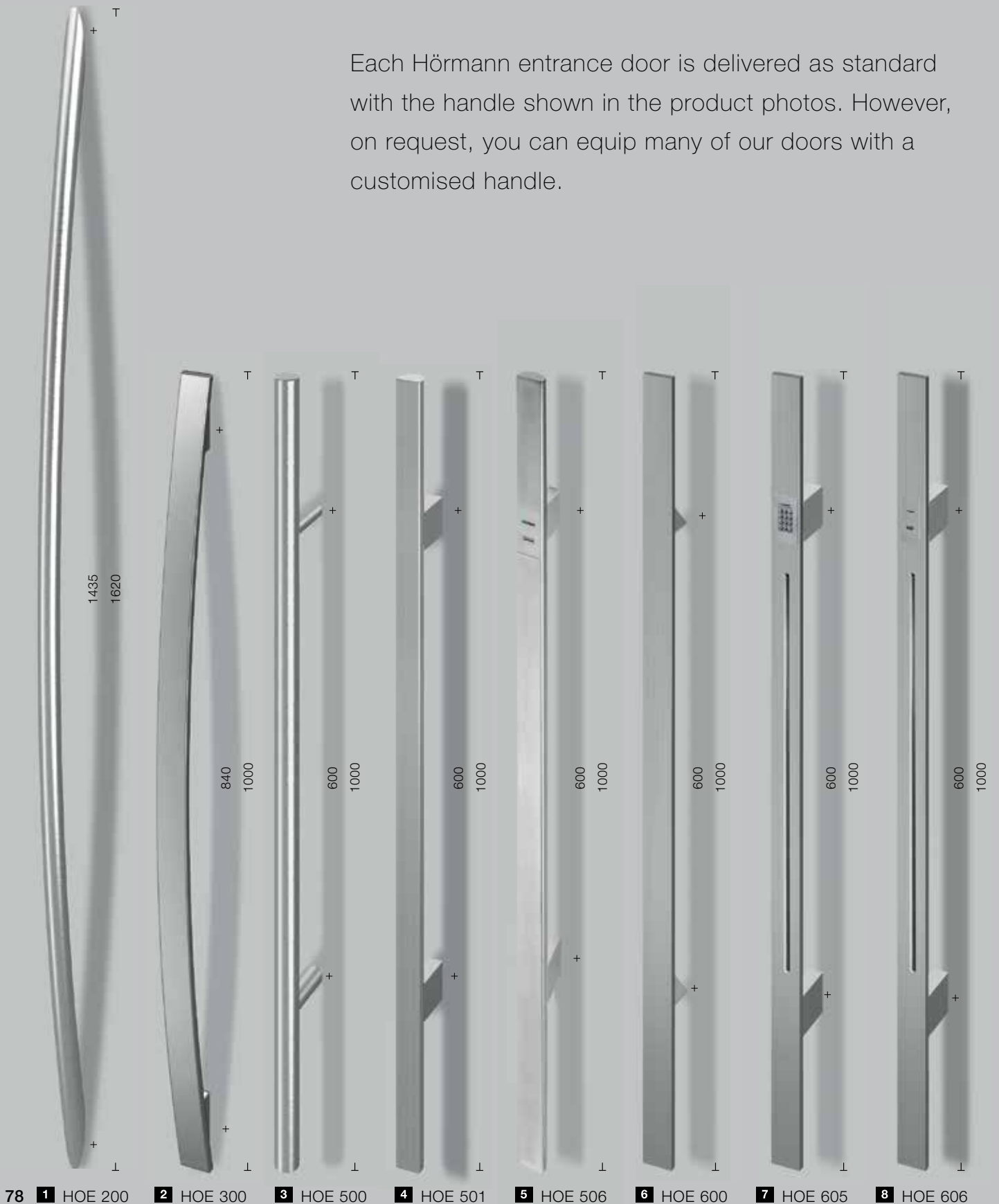

78 **1** HOE 200

**2** HOE 300

**3** HOE 500

**4** HOE 501

**5** HOE 506

**6** HOE 600

**7** HOE 605

**8** HOE 606



**9** HOE 610



**10** HOE 615



**11** HOE 620



**12** HOE 700



**13** HOE 701



**14** HOE 706



**15** HOE 710



**16** HOE 740

# EXTERIOR HANDLES

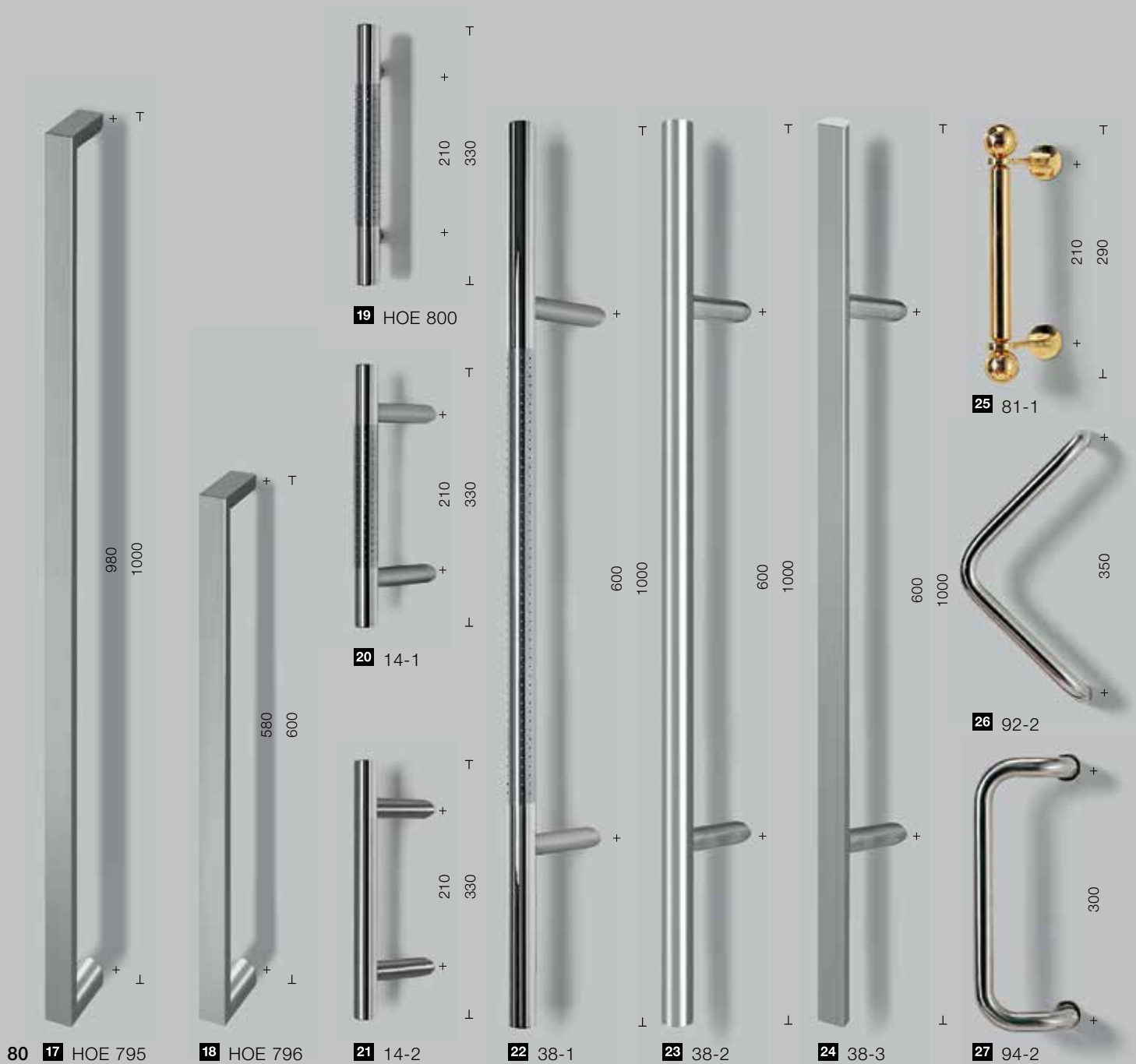

+ mm += axis dimension  
 ⊥ mm ⊥= handle length

All details in mm



# Exterior handles overview

Handle	Description	ThermoCarbon	ThermoPlan Hybrid	ThermoSafe Hybrid / ThermoSafe	Thermo65	TopComfort
1	HOE 200	Brushed stainless steel	●	●	●	
2	HOE 300	Brushed stainless steel	●	●	●	
3	HOE 500	Brushed stainless steel	●	●	●	
4	HOE 501	Brushed stainless steel	●	●	●	
5	HOE 506	Brushed stainless steel, prepared for a code switch		●	●	
6	HOE 600	Brushed stainless steel	●	●	●	
7	HOE 605	Brushed stainless steel, prepared for a code switch		●	●	
8	HOE 606	Brushed stainless steel, prepared for a finger-scan	●	●	●	
9	HOE 610	Brushed stainless steel	●	●	●	
10	HOE 615	Brushed stainless steel	●	●	●	
11	HOE 620	Brushed stainless steel	●	●	●	
12	HOE 700	Polished stainless steel with decorative centre part	●	●	●	
13	HOE 701	Stainless steel with decorative centre part	●	●	●	
14	HOE 706	Brushed stainless steel, prepared for a finger-scan	●	●	●	
15	HOE 710	Brushed stainless steel	●	●	●	● (G 710)
16	HOE 740	Brushed stainless steel	●	●	●	● (G 740)
17	HOE 795	Brushed stainless steel	●	●	●	
18	HOE 796	Brushed stainless steel	●	●	●	
19	HOE 800	Polished stainless steel with decorative centre part		●	●	
20	14-1	Polished stainless steel with decorative centre part		●	●	●
21	14-2	Brushed stainless steel		●	●	●
22	38-1	Polished stainless steel with decorative centre part		●	●	●
23	38-2	Brushed stainless steel		●	●	●
24	38-3	Brushed stainless steel			●	
25	81-1	Polished brass				●
26	92-2	Brushed stainless steel		●	●	●
27	94-2	Brushed stainless steel		●	●	●

# Attractive lever handles

**ThermoPlan Hybrid, ThermoSafe Hybrid, ThermoSafe** and **TopComfort doors** are equipped with the aluminium interior lever Rondo as standard. This lever is also available in stainless steel or a RAL colour of your choice to match the stainless steel interior levers on your internal doors. In addition, the stylish lever handles Caro and Okto are available in stainless steel.

**ThermoCarbon doors** are equipped with stainless steel interior lever Caro as standard.

**Thermo65 entrance doors** are available with a stainless steel lever handle D-110 and oval rose escutcheon as standard.



Aluminium lever handle Rondo in matt Traffic white, RAL 9016, for ThermoPlan Hybrid, ThermoSafe Hybrid, ThermoSafe and TopComfort



Stainless steel lever handle Caro for ThermoCarbon, ThermoPlan Hybrid, ThermoSafe Hybrid and ThermoSafe



Stainless steel lever handle Okto for ThermoPlan Hybrid, ThermoSafe Hybrid and ThermoSafe



Stainless steel lever handle D-110 for Thermo65 (standard interior lever)



Stainless steel lever handle set Type D-110 for Thermo65



Stainless steel lever handle set Type D-210 for Thermo65



Stainless steel lever handle set Type D-310 for Thermo65



Stainless steel lever handle set Type D-510 for Thermo65

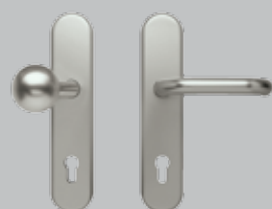

ES 0 / ES 1 lever/knob handle set with knob (shown: ES 1 in stainless steel) for Thermo65

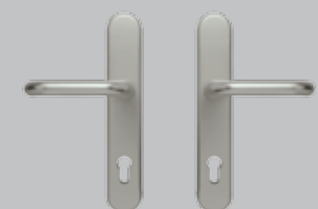

Lever handle set ES 0 / ES 1 (shown ES 0 in stainless steel) for Thermo65

# Individual colour combinations

For the exclusive ThermoCarbon entrance door styles 300, 301, 302, 304, 305, 308 and 312, you have the option to individually coordinate the flush-fitting handle bar and recessed grip with the colour of your entrance door or embellishment.



**Style 300**  
In Traffic white RAL 9016, matt, handle bar in Traffic white RAL 9016, matt, recessed grip in door colour



**Style 300**  
In the preferred colour Slate grey, RAL 7015, matt, handle bar in White aluminium RAL 9006, silk-gloss, recessed grip in the preferred colour White aluminium RAL 9006, silk-gloss



**Style 301**  
In Hörmann preferred colour CH 703 Anthracite, fine structure matt, aluminium embellishment in preferred colour Ruby red RAL 3003, matt, handle bar in preferred colour Ruby red RAL 3003, matt, and recessed grip in door colour

## Optional colour combinations for styles 304, 305, 306, 314



**Style 304**  
In Traffic white RAL 9016, matt, stainless steel handle, recessed grip in preferred colour White aluminium RAL 9006, silk-gloss



**Style 305**  
In preferred colour Slate grey RAL 7015, matt, aluminium embellishment in preferred colour White aluminium RAL 9006, silk-gloss, stainless steel handle, recessed grip in preferred colour White aluminium RAL 9006, silk-gloss



**Style 305**  
In Hörmann preferred colour CH 703 Anthracite, fine structure matt, aluminium embellishment in preferred colour White aluminium RAL 9006, silk-gloss, stainless steel handle, recessed grip in door colour

## Optional colour combinations for style 308



**Style 308**  
In Traffic white, RAL 9016, matt, handle bar and recessed grip in Traffic white RAL 9016, matt



**Style 308**  
In preferred colour Slate grey RAL 7015, matt, handle bar in White aluminium RAL 9006, silk-gloss, recessed grip in door colour



**Style 308**  
In Hörmann preferred colour CH 703 Anthracite, fine structure matt, handle bar and recessed grip in preferred colour Ruby red RAL 3003, matt

# Our designer handles

A continuous design handle not only rounds off the exclusive appearance of your **ThermoCarbon, ThermoPlan Hybrid, ThermoSafe Hybrid** or **ThermoSafe entrance door**, it is also extremely comfortable to operate. As a result, small children can also open the door using this handle. DesignPlus handles offer you elegant embellishments to create a customised door. This lets you adjust both the handle and handle embellishment to match the colour of the door and the rest of your home.

### Effective illumination with LED light strip

The design handle G 750 and the DesignPlus handle G 760 are also optionally available with a light strip integrated into the handle. This particularly emphasizes your ThermoSafe or ThermoSafe Hybrid entrance door at night.

Persuasive elegance in 3 colours and in RAL to choose: the design handle G 750



Delivered as standard in E6/ EV 1, with stainless steel end caps



No surcharge for the door surface colour, with stainless steel end caps



Optionally available in preferred colour (shown in Ruby red RAL 3003, matt) or RAL to choose deviating from door surface colour, with stainless steel end caps



## HANDLE COLOURS

Exclusive design to suit your taste: DesignPlus handle G 760



Handle bar in anodised aluminium E6 / EV 1 as standard, with stainless steel end caps (shown: handle embellishment in Hörmann colour CH 703, matt textured Anthracite)



Handle bar in the door surface colour at no surcharge, with stainless steel end caps (shown: handle embellishment in Hörmann colour CH 703, matt textured Anthracite)



Handle bar optionally in preferred colour (shown: Ruby red RAL 3003) or RAL to choose deviating from the door surface colour, with stainless steel end caps (shown: handle embellishment in Hörmann colour CH 703, matt textured Anthracite)



Handle embellishment in anodised aluminium E6 / EV 1 as standard (handle bar in anodised aluminium E6 / EV 1)



Handle embellishment in door surface colour at no surcharge (shown: handle bar in anodised aluminium E6 / EV 1)



Handle embellishment optionally in preferred colour or RAL to choose deviating from the door surface colour (shown: handle bar in anodised aluminium E6 / EV 1)



Handle embellishment optionally in five Decograin decors (shown: handle bar in anodised aluminium E6 / EV 1)

Handle embellishments are also available in Decograin timber designs



**Decograin Light Oak:**  
Light, warm oak design

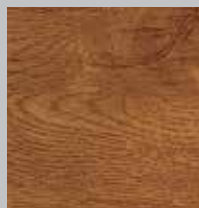

**Decograin Golden Oak:**  
Medium-brown, golden yellow oak design

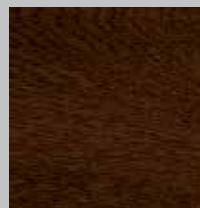

**Decograin Dark Oak:**  
Walnut-coloured oak design

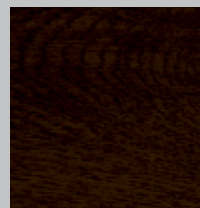

**Decograin Night Oak:**  
Dark, intense oak design

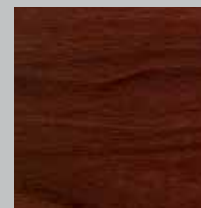

**Decograin Rosewood:**  
Mahogany-coloured timber design



# Securing excellent properties

Fingerprint, code or radio – Hörmann offers automatic locks for more security and convenient operation. **ThermoPlan Hybrid, ThermoSafe Hybrid** and **ThermoSafe entrance doors** are optionally available at no surcharge with the S5 automatic lock that automatically and securely locks your entrance door at four different points as soon as the door falls shut. You can also equip your **ThermoCarbon entrance door** with the 7-point S7 automatic lock at no surcharge. You may, of course, also continue to use a key to lock and unlock your door.



## S5 / S7 automatic lock

The bolt lock with mechanical self-locking is available **optionally without a surcharge**. When the door falls shut, the bolts automatically extend and securely lock the entrance door. In addition, the door can also be secured via the lock with another bolt, e.g. if you are away on holiday.

## Automatic lock S5 / S7 Comfort

The automatic lock S5 / S7 Comfort locks your entrance door automatically with bolts. An additional electric motor enables unlocking of the door via external control elements, such as a finger-scan, code switch or hand transmitter (see following pages). In this process, the power and data signals are transmitted from door frame to door leaf via a cable in the door rebate. With the holiday function, you can switch off the control elements or the radio, so that nobody can open the entrance door while you are away. S5 / S7 Comfort is prepared for connection to a button or an existing house intercom and is ideally suited for blocks of flats. This way, you can conveniently open your entrance door at the press of a button, for example from an upper storey.

### Access control system ■ NEW

With the easy-to-use access control system LightAccess you can open your entrance door via a changing colour code on your smartphone display. Via the LightPass app or the LightPass website, you can conveniently send 12 permanent and 6 time-limited access codes to your family and friends online. The recipient of the code obtains quick and easy access because no software needs to be installed on the mobile phone.

## S5 / S7 Code automatic lock

Very convenient: with the automatic lock, simply entering your personal security code opens your entrance door from outside. You can save up to 20 different codes.



S5 / S7 Comfort – open the door at the push of a button



S5 / S7 Comfort – door opening with the access control system LightAccess ■ NEW



S5 / S7 Code – door is opened by entering a code – fitted in the door leaf



Elegant code switch with touch-sensitive touch surface (optional for ThermoSafe Hybrid / ThermoSafe entrance doors)



Code switch – fitted in the door handle

### S5 / S7 Scan automatic lock

Open your entrance door with your fingerprint. The finger-scan\* recognises up to 150 fingerprints and can be easily taught in without a computer. Furthermore, you can control a further device such as the exterior lighting or your garage door operator in addition to the entrance door lock.



### S5 / S7 Smart automatic lock

You can conveniently open your entrance door with an optional hand transmitter or a radio switch. The extremely secure radio system ensures that no unauthorised person can copy your radio signal. Another advantage is that you can use the same hand transmitter to operate your Hörmann garage door or entrance gate. The S5 / S7 Smart remote control can also be installed in the S5 / S7 Scan and S5 Code convenience packages.

### S5 / S7 Bluetooth automatic lock ■ NEW

Opening and closing your door via Bluetooth using your smartphone is even more convenient. Lock and unlock your entrance door using the user-friendly Hörmann **BlueSecur app**. In addition, other user permissions\*\* can be permanently or temporarily transferred to other smartphones, so that every family member always has their “entrance door opener” with them.



S5 / S7 Scan – door is opened by fingerprint – fitted in the door leaf



Finger-scan in the door handle



S5 / S7 Smart – open the door using BiSecur radio



Simple smartphone operation of the automatic lock using the Hörmann BlueSecur app

## Opening aid ECTurn

ThermoCarbon, ThermoSafe Hybrid and ThermoSafe entrance doors can now be optionally equipped with the ECTurn. The opening aid is integrated elegantly into the door leaf and frame or available as a surface-mounted variant. With the automatic lock and ECTurn, you can automatically open and close your door. Due to low energy operation, the opening aid requires no safety devices. The force of the ECTurn is adapted to the leaf, minimising potential hazards for persons.



Convenient opening with the ECTurn opening aid. The opening aid is also available elegantly integrated into the door leaf and frame.

## Door operator HDO 200 ■ NEW

The **new door operator HDO 200**, optional for all TopComfort aluminium entrance doors, **in combination with a door version without threshold** incl. retractable bottom seal, is the ideal **solution for barrier-free door entrances**. The inconspicuous Flatscan sensor monitors the area of travel and ensures safe operation. The operator can be conveniently operated via buttons, radar / movement detectors, etc., optionally with BiSecur radio technology with all Hörmann hand transmitters, radio control elements, radio internal push buttons or the new BiSecur app. All door parameters such as opening or closing speed can be individually adjusted. Thanks to speed control, the operator not only operates safely in terms of opening and closing speeds, but is also pleasantly quiet.



For barrier-free entrances in combination with a door version without threshold: the door operator HDO 200



Select your hand transmitter or radio switch from our broad accessories programme. More information can be found in the Garage Door and Entrance Gate Operators brochure.

# SIZES AND FITTING DATA

## ThermoCarbon entrance door dimensions

Version	Overall frame dimension (ordering size)	Structural opening	Clear frame dimension
Standard	Max. 1340 × 2350	Max. 1360 × 2360	Max. 1140 × 2230
XXL	Max. 1340 × 3000	Max. 1360 × 3010	Max. 1140 × 2880

## ThermoCarbon side element dimensions

Vertical profile construction	Side element height	TM side element width	TM entrance door width
1-sided	Max. 3000	300 – 1600	Max. 1300
2-sided	Max. 3000	300 – 1600	Max. 1260

The max. transport size of a door assembly (incl. side elements, transom lights and substructure profiles) must not exceed 2700 mm on any side.

Coupling construction	Side element height	TM side element width	TM entrance door width
1/2-sided	Max. 3000	340 – 1600	1340

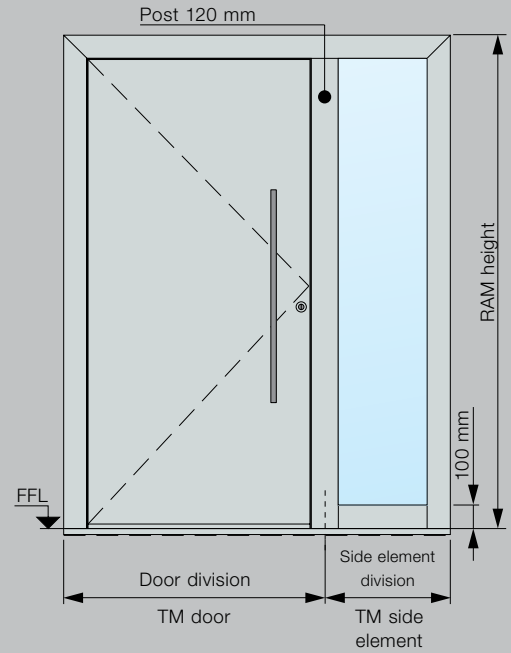

## ThermoCarbon

### Bottom spacer profile / transport protection

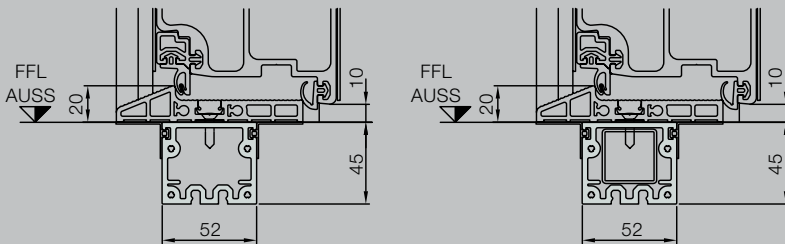

For vertical profile constructions with inserted, continuous tubular supports (shown on right).

### Horizontal view of door

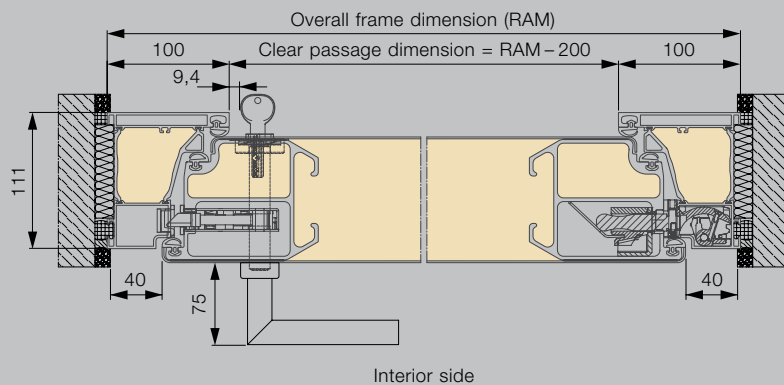

### Vertical view of door

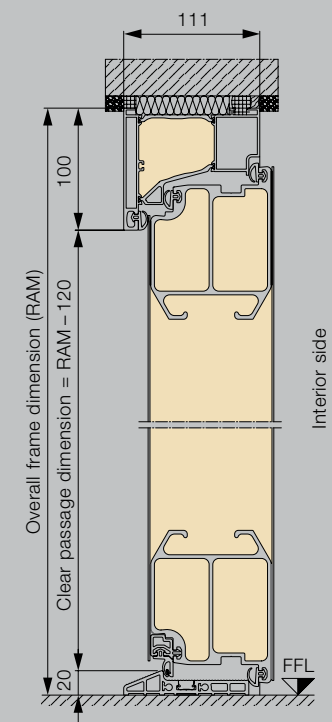

All dimensions in mm



## ThermoPlan Hybrid entrance door sizes ■ NEW

70 mm frame version	Overall frame dimension* (ordering size)	Structural opening*	Clear frame dimension
Standard	Max. 1250 × 2250	Max. 1270 × 2260	Max. 1110 × 2180
Oversize	Max. 1250 × 2350	Max. 1270 × 2360	Max. 1110 × 2280
XXL	Max. 1250 × 2500	Max. 1270 × 2510	Max. 1110 × 2430

## ThermoPlan Hybrid side element sizes

Vertical profile construction	Side element height*	TM side element width*	TM entrance door width*
1-sided	Max. 3000	260 – 1600	Max. 1230
2-sided	Max. 3000	260 – 1600	Max. 1210

The max. transport size of a door assembly (incl. side elements, transom lights and substructure profiles) must not exceed 2700 mm on any side.

Coupling construction	Side element height*	TM side element width*	TM entrance door width*
1 / 2-sided	Max. 3000	300 – 2500**	1250

\* For 110 mm frames + 40 mm

\*\* With Reflo or Micrograin

## ThermoPlan Hybrid

### Bottom spacer profile / transport protection



For vertical profile constructions with inserted, continuous tubular supports (shown on right).

### Horizontal view of door

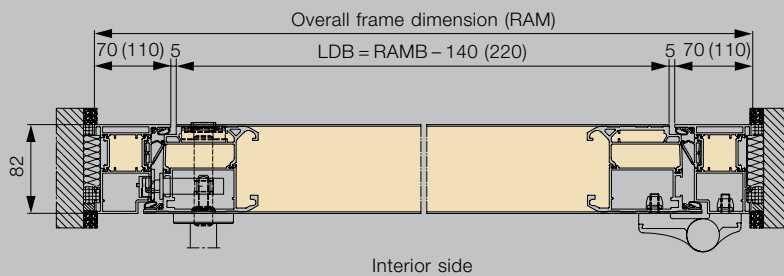

### Vertical view of door

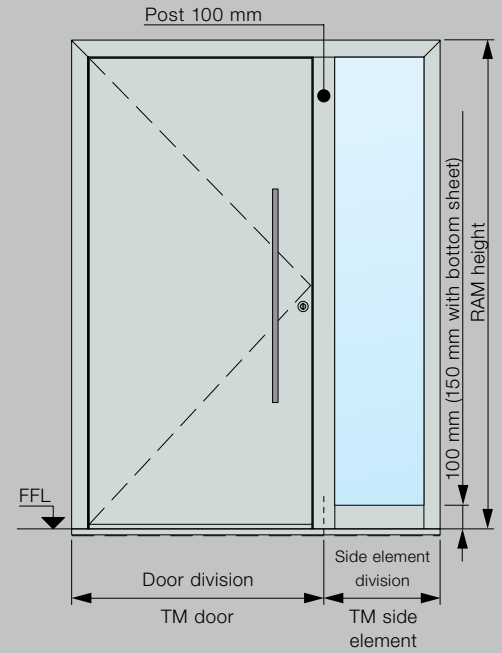
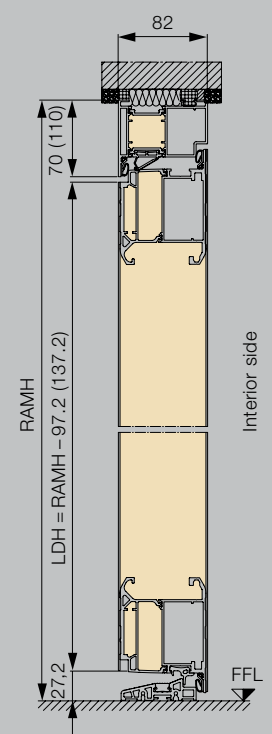

# SIZES AND FITTING DATA

## ThermoSafe Hybrid entrance door sizes ■ NEW / ThermoSafe

70 mm frame version	Overall frame dimension* (ordering size)	Structural opening*	Clear frame dimension
Standard	Max. 1250 × 2250	Max. 1270 × 2260	Max. 1110 × 2180
Oversize	Max. 1250 × 2350	Max. 1270 × 2360	Max. 1110 × 2280
XXL	Max. 1250 × 2500	Max. 1270 × 2510	Max. 1110 × 2430

## ThermoSafe Hybrid side element sizes ■ NEW / ThermoSafe

Vertical profile construction	Side element height*	TM side element width*	TM entrance door width*
1-sided	Max. 3000	260 – 1600	Max. 1230
2-sided	Max. 3000	260 – 1600	Max. 1210

The max. transport size of a door assembly (incl. side elements, transom lights and substructure profiles) must not exceed 2700 mm on any side.

Coupling construction	Side element height*	TM side element width*	TM entrance door width*
1/2-sided	Max. 3000	300 – 2500**	1250

\* For 110 mm frames + 40 mm

\*\* With Reflo or Micrograin glazing

## ThermoSafe Hybrid ■ NEW / ThermoSafe

### Bottom spacer profile / transport protection

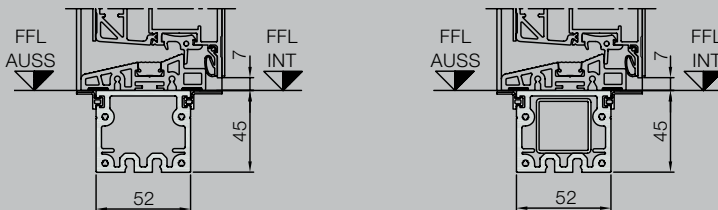

For vertical profile constructions with inserted, continuous tubular supports (shown on right).

### Horizontal view of door

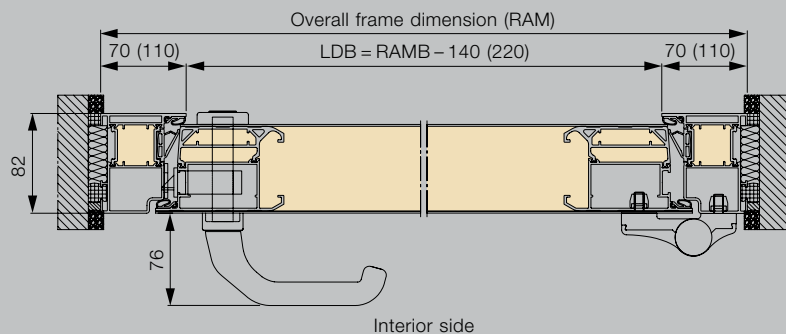

### Vertical view of door

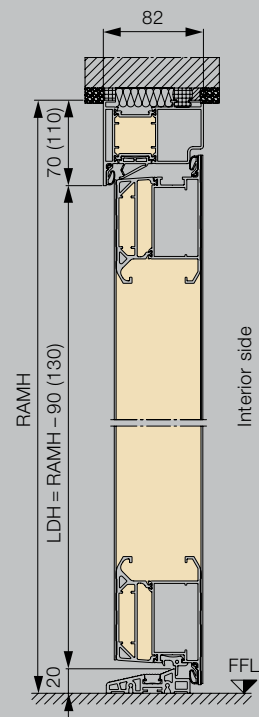

All dimensions in mm

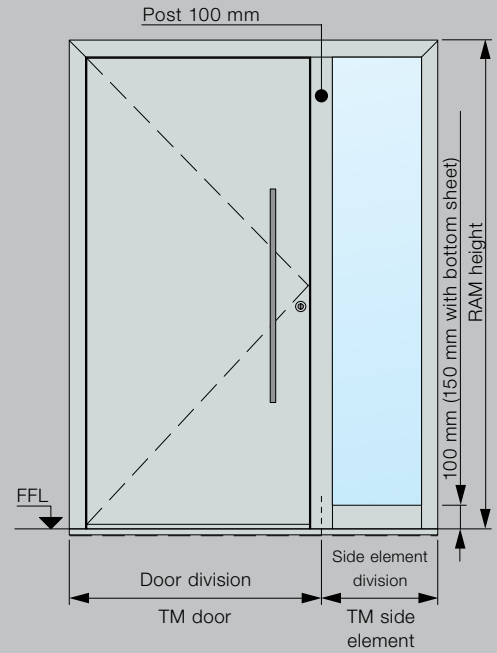

## Thermo65 standard sizes

Overall frame dimension (ordering size)	Structural opening	Clear frame dimension
1000 × 2100	1020 × 2110	850 × 2005
1100 × 2100	1120 × 2110	950 × 2005

## Thermo65 special sizes

Styles	Overall frame dimension (ordering size)
010, 600, 700, 750, 800, 810	700 – 1250 × 1875 – 2250
015, 515	875 – 1250 × 1875 – 2250
100, 410, 430	875 – 1100 × 1875 – 2186
820, 850, 900	800 – 1250 × 1875 – 2250

## Thermo65 side element standard sizes

Overall frame dimension (ordering size) glass infill
400 × 2100

## Thermo65 side element special sizes

Overall frame dimension (ordering size) glass infill
300 – 1000* × 700 – 2250

\* Transom light not possible from a width of 500 mm. Door sets with side elements do not contribute to the static equilibrium, which must be guaranteed by the building structure.

## Thermo65 transom light special sizes

Overall frame dimension (ordering size) glass infill
700 – 2250 × 300 – 500

## Thermo65

### Frame variants

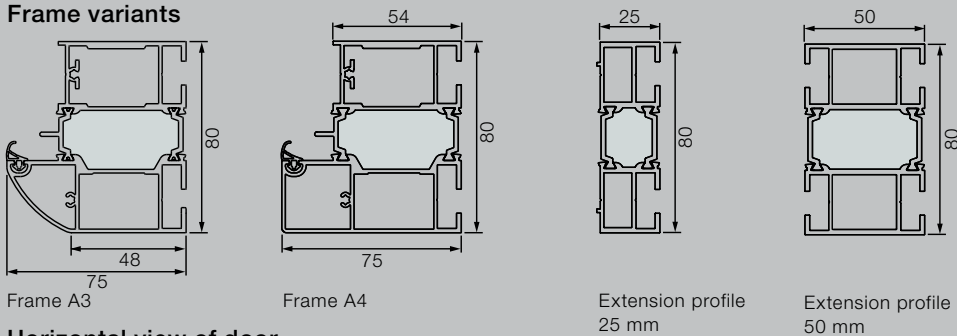

### Horizontal view of door

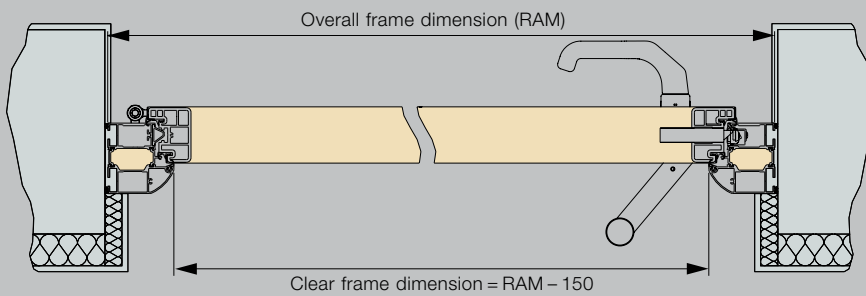

### Horizontal view of side element

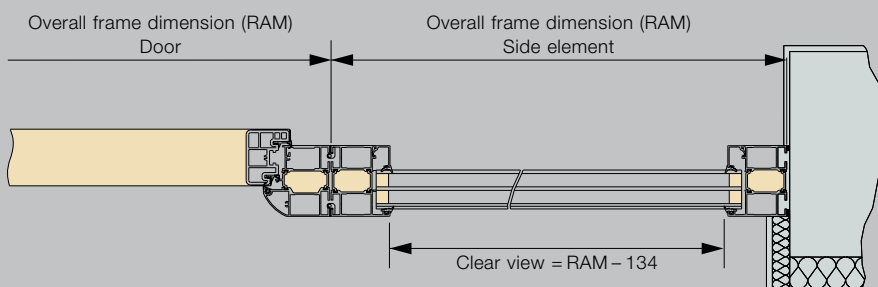

### Vertical view of door

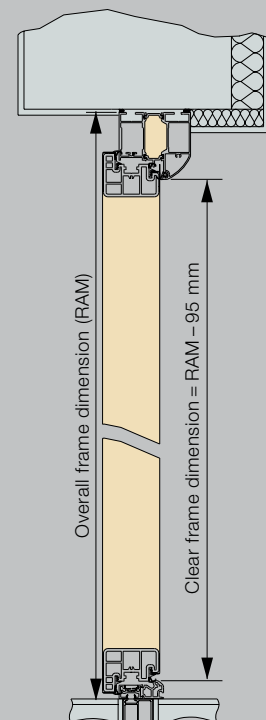

All dimensions in mm

# SIZES AND FITTING DATA

## TopComfort entrance door sizes

70 mm frame version	Overall frame dimension* (ordering size)	Structural opening*	Clear frame dimension
Standard	Max. 1300 x 2500	Max. 1270 x 2510	Max. 1160 x 2430

## TopComfort side element sizes

Vertical profile construction	Side element height*	TM side element width*	TM entrance door width*
1-sided	Max. 3000	260 – 1600	Max. 1230
2-sided	Max. 3000	260 – 1600	Max. 1210

The max. transport size of a door assembly (incl. side elements, transom lights and substructure profiles) must not exceed 2700 mm on any side.

Coupling construction	Side element height*	TM side element width*	TM entrance door width*
1/2-sided	Max. 3000	300 – 1600	1250

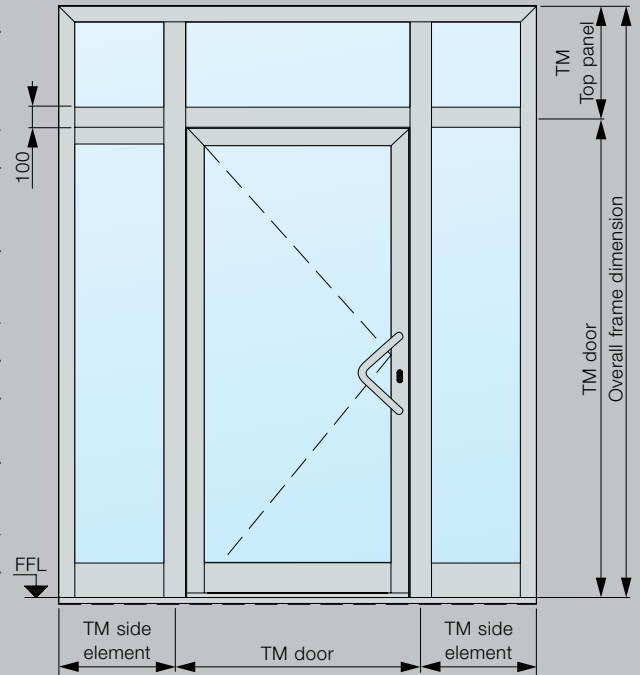

## TopComfort

### Bottom spacer profile

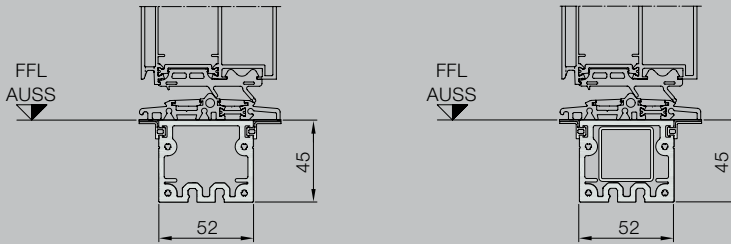

For vertical profile constructions with inserted, continuous tubular supports (shown on right).

### Horizontal view of door

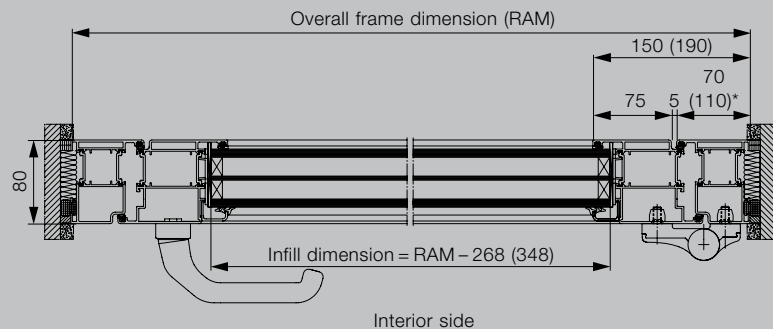

\* Optional frame width

### Vertical view of door

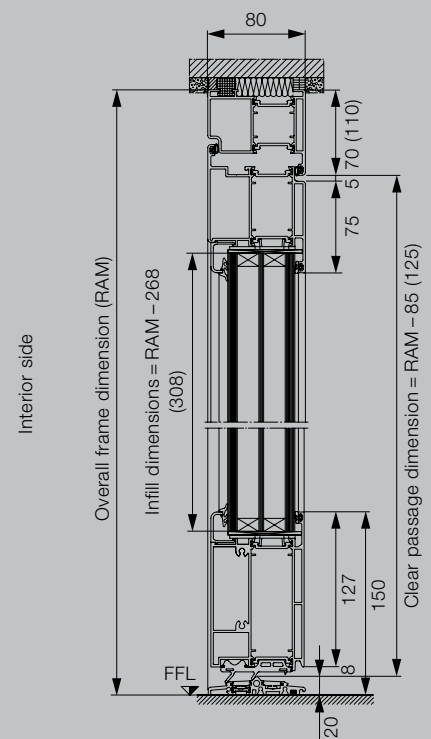

All dimensions in mm

# Experience Hörmann quality in new construction and modernisation

Hörmann provides an excellent basis for comprehensive planning. Carefully matched solutions offer you the very best in perfectly designed products for every area.

- **Garage doors**

Optimally match your personal architectural style: up-and-over or sectional doors made of steel or timber.

- **Gate and Door Operators**

Enjoy extra convenience and break-in-resistant security with Hörmann operators for garage doors and entrance gates. You can profit from the convenience of Hörmann door operators in your residential space as well.

- **Entrance doors**

Our comprehensive entrance door ranges include models that fit almost every need and requirement.

- **Steel doors**

Sturdy doors for your entire home, from basement to roof.

- **Frames**

Choose from our comprehensive range of products for new construction, expansion and modernisation.



Garage doors and entrance gate operators



Thermo65 / Thermo46 entrance doors



Steel doors



# Hörmann: Quality without Compromise



Hörmann KG Amshausen, Germany



Hörmann KG Antriebstechnik, Germany



Hörmann KG Brandis, Germany



Hörmann KG Brockhagen, Germany



Hörmann KG Dissen, Germany



Hörmann KG Eckelhausen, Germany



Hörmann KG Freisen, Germany



Hörmann KG Ichttershausen, Germany



Hörmann KG Werne, Germany



Hörmann Alkmaar B.V., Netherlands



Hörmann Legnica Sp. z o.o., Poland



Hörmann Beijing, China



Hörmann Tianjin, China



Hörmann LLC, Montgomery IL, USA



Hörmann Flexon LLC, Burgettstown PA, USA



Shakti Hörmann Pvt. Ltd., India

Hörmann is the only manufacturer worldwide that offers you a complete range of all major building products from one source. We manufacture in highly-specialised factories using the latest production technologies. The close-meshed network of sales and service companies throughout Europe, and activities in the USA and Asia, make Hörmann your strong partner for first-class building products, offering “Quality without Compromise”.

**GARAGE DOORS**  
**OPERATORS**  
**INDUSTRIAL DOORS**  
**LOADING EQUIPMENT**  
**HINGED DOORS**  
**DOOR FRAMES**