



GARAGE DOORS ROLLMATIC

20% higher opening speed and smart operation
with the roller garage door operator RollMatic 2

HÖRMANN





4

Good reasons
to try Hörmann



14

Inspirations



20

Design
Equipment
Accessories

Responsibility for generations

The Hörmann family business has over 85 years of experience as a construction component specialist. This gives us an obligation to both current and future generations. That's why environmental responsibility plays such an important role for us. With this in mind, we develop innovative solutions for sustainable products and intelligent environmental protection.



“A GOOD REPUTATION MUST BE EARNED.”

August Hörmann

In keeping with the tradition started by the company's founder, the Hörmann brand is a true promise of quality and, with sales of over 20 million doors and operators, is one of Europe's most successful suppliers. Due to the comprehensive international sales and service network, Hörmann is your strong partner for high-quality construction components.

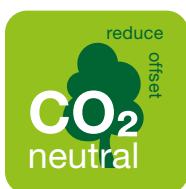

WE THINK AND ACT GREEN. As a family business, we are very conscious of our responsibility to future generations. The Hörmann climate protection strategy aims to reduce and avoid CO₂ emissions. We cover 100% of our electrical power needs at all European production locations with purchased green electricity. We are also investing in a clean future with other measures such as the use of recycled paper, CO₂-neutral postal shipping and the recycling of transport packaging to save more than 75,000 tons of CO₂ every year. We work with ClimatePartner to offset the emissions that we do generate by supporting certified climate protection projects. In particular, we offset all CO₂ emissions produced in manufacture of products for residential construction as standard.



You can find further information at
www.hoermann.com/sustainability



ClimatePartner
certified product
climate-id.com/XNEBKC



CO₂
measure
reduce
contribute

Brand quality made in Germany



The family-owned company Hörmann offers all important construction components for building and renovating projects from a single source. We manufacture in highly specialised factories using state-of-the-art production technologies. Our employees work intensively on new products, continual further developments and improvements to details. The results are patents and unique products on the market.





10-year warranty ¹⁾

LONG-LASTING. GUARANTEED. All major door and operator components are developed and manufactured by Hörmann. Endurance tests under real conditions ensure mature series products with Hörmann quality. Thanks to this and uncompromising quality assurance, you receive a 10-year warranty on all Hörmann roller garage doors RollMatic, RollMatic T and garage horizontal doors RollMatic OD, as well as a 5-year warranty on all Hörmann operators ¹⁾.

¹⁾ The complete warranty conditions can be found at: www.hoermann.com



Roller garage door with tension spring assembly

RELIABLE COUNTERBALANCE. The counterbalance system ²⁾ integrated in the side guides supports the operator during the opening and closing of the door and prevents damage to the operator mechanism. The multiple spring assemblies and the double lifting cables prevent the door leaf from crashing in every position. In case of emergency, the door can be easily opened by hand. A crank handle ²⁾ is not necessary for this purpose for roller garage doors.

²⁾ Not with roller garage door RollMatic T

Patented tension spring technology with spring-in-spring system for roller garage door RollMatic



Universally applicable

Roller garage doors and garage horizontal doors open vertically and offer maximum space inside and in front of the garage. The shape of the garage door opening is not of prime importance when fitting the doors. Whether square, chamfered, with segmental or Norman arch – Hörmann garage doors always fit. The RollMatic is also available as an external roller garage door for fitting in front of the opening for problematic fitting situations with little sideroom.





ROLLER GARAGE DOOR ROLLMATIC.

The compact roller garage doors are the best choice if the ceiling area of your garage should remain free or if your garages are too small for a garage horizontal door or sectional door.

The roller garage door curtain compactly winds up into the lintel of the door opening, thus allowing you to use the ceiling for lamps or as an additional storage space.

→ Further information can be found starting on page 26.



ROLLER GARAGE DOOR ROLLMATIC T.

The inexpensive roller garage door with powerful tubular operator creates more room in front of and inside the garage. The door curtain is guided via a guide roller and guide channel and ensures smooth door travel.

→ Further information can be found starting on page 30.



GARAGE HORIZONTAL DOOR

ROLLMATIC OD. For garages with a particularly low headroom, space-saving garage horizontal doors are especially suitable. The door curtain is guided under the ceiling through narrow booms. Thanks to the space-saving, lateral operator fitting, the RollMatic OD has a required headroom of only 60 mm.

→ Further information can be found starting on page 32.

Permanently beautiful door appearance

Regular opening leaves marks on the door curtain due to the design of the roller garage door. In addition to the high-quality surface coating, innovative solutions such as special bearing rings, the position of the roller and the new DuraBelt reduce these marks to a minimum. This way you can enjoy your attractive door for a long time.



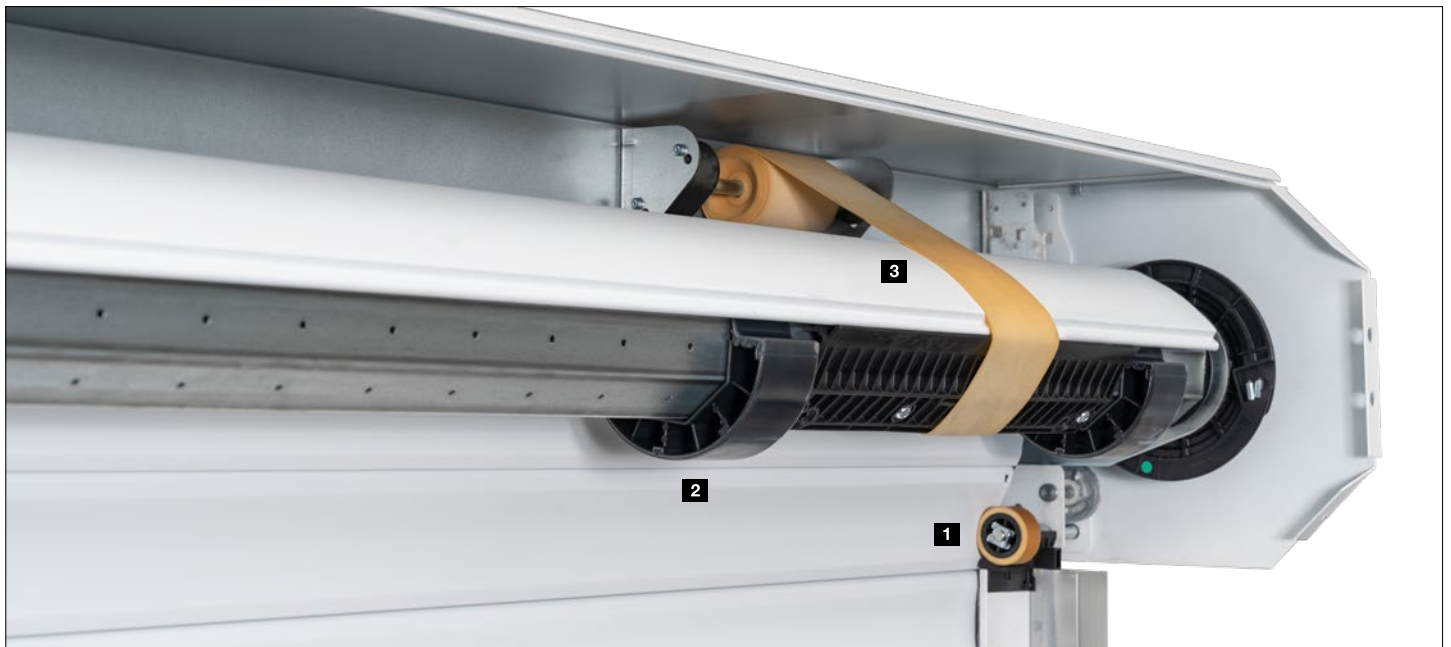

Only from Hörmann
Wear-resistant bearing rings on the roller garage door RollMatic

FEWER MARKS THANKS TO THE STANDARD DESIGN.

The rollers **1** guiding the door curtain above the booms are positioned in such a way that design-related marks can only occur in the less visible area behind the booms. With the roller garage door RollMatic, wear-resistant bearing rings **2** additionally minimise marks on the inside of the top profiles.

Only from Hörmann
DuraBelt

ADDITIONAL SURFACE PROTECTION. Dirt can cause small scratch marks on the door curtain when it is rolled up. The DuraBelt **3** significantly reduces these scratches. When rolling up, several belts are placed between the individual layers of the door curtain, thus reducing the contact with the profiles to a minimum.

→ Further information can be found starting on page 27.



Watch the video on YouTube
or at www.hormann.co.uk/media-centre

Intelligent operating comfort

Control your garage door and entrance gate operators, door operators, entrance door locks, lights and other devices simply, safely and conveniently via hand transmitter, radio switch or smartphone. All operators, receivers and control elements with BiSecur radio technology are 100% compatible with each other.





Only from Hörmann

CERTIFIED SECURITY. The bidirectional radio system BiSecur with particularly secure encryption protocol and stable, interference-free range makes sure that no one can copy your radio signal. This is also confirmed by the security experts of Bochum University and independent test institutes.



Watch the video on YouTube
or at www.hormann.co.uk/media-centre

INTELLIGENT TECHNOLOGY. Hörmann operators offer more convenience, smart functions and intelligent technology. Our elegant hand transmitters allow you to open your door from your car. Or you can simply use your smartphone as a door opener with the Hörmann BlueSecur app ¹⁾ or the Hörmann Smart Home control centre homee ²⁾.



Watch the video on YouTube
or at www.hormann.co.uk/media-centre

→ Further information can be found starting on page 38.

¹⁾ For roller garage door RollMatic T optionally in conjunction with the external HET-BLE
²⁾ For roller garage door RollMatic and garage horizontal door RollMatic OD

At the press of a button, the colour of the LED on the hand transmitter HS 5 BS or the internal push button FIT 5 BS indicates the door position ²⁾.



With the Smart Home control centre homee, you can control all door functions via your tablet or smartphone ²⁾.



THE PERFECT MATCH FOR YOUR HOME.

To perfectly match your door to the architectural style of your home, we offer the roller garage doors RollMatic. RollMatic T and the garage horizontal door RollMatic OD in 16 door colours. For an especially elegant door appearance, we recommend the colour Noir 2100 Sablé Anthracite metallic.

→ Further information can be found starting on page 24.

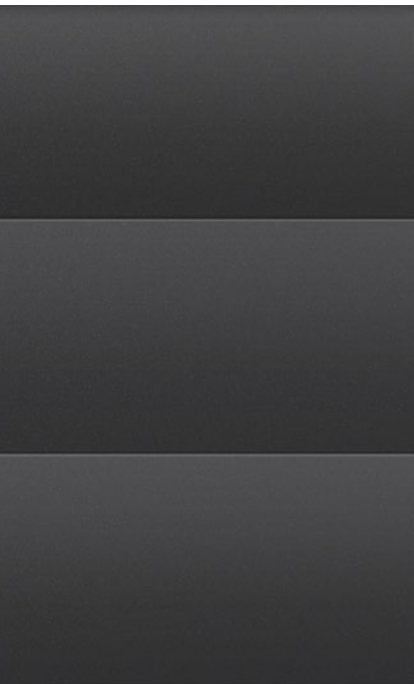



TOP. Roller garage door and side door in Moss green RAL 6005

BOTTOM LEFT. Detail of Noir 2100 Sablé

BOTTOM CENTRE. Roller garage door in Noir 2100 Sablé

BOTTOM RIGHT. Roller garage door in Traffic white RAL 9016



NATURAL DOOR APPEARANCE. The particularly wear-resistant Decograin surface finish and the inexpensive Decopaint surface finish have a convincing real timber look.

→ Further information can be found starting on page 25.



TOP LEFT. Roller garage door in Decograin Rosewood

TOP RIGHT. Detail Decograin Golden Oak

BOTTOM. Roller garage door in Decograin Golden Oak



EXTERNAL ROLLER GARAGE

DOOR. The RollMatic is also available as an external roller garage door for fitting in front of the opening if your garage has little headroom and / or sideroom. The external roller garage door is supplied as a complete package with a matching operator. The side guides and the curtain cover come in the same colour as the door, or in the base colour of the decor for Decopaint, to create a uniform and harmonious appearance.

→ Further information can be found starting on page 27.





TOP LEFT. External roller garage door in Light grey RAL 7035

TOP RIGHT. Roller garage door and side door in Traffic white RAL 9016

BOTTOM LEFT. External roller garage door in Light grey RAL 7035



SIDE DOORS. At Hörmann, side doors are given just as much consideration, as the overall appearance is only perfect if the side door matches the roller garage door. The side door NT 60 is thus available in all surface finishes and colours. The high-quality 60 mm aluminium frame construction is the ideal frame for the door infill, which is fastened with glazing beads as standard.

→ Further information can be found starting on page 37.





22



24

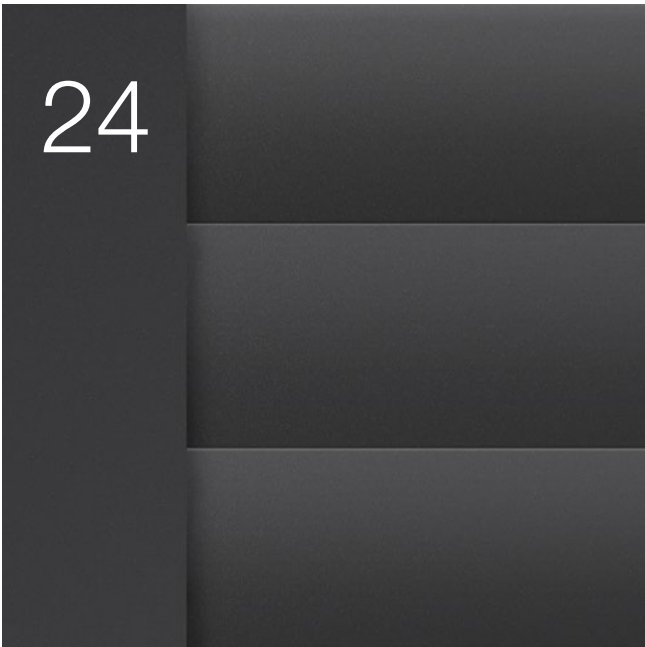

38



Design. Equipment. Accessories.

- 22 Profile versions and surface finishes
- 24 Colours and decors
- 26 Roller garage door RollMatic
- 30 Roller garage door RollMatic T
- 32 Garage horizontal door RollMatic OD
- 36 Optional extras
- 37 Side doors
- 38 Accessories
- 40 Dimensions and technical manual

Profile versions and surface finishes

Roller garage doors RollMatic, RollMatic T and garage horizontal door RollMatic OD

Elegant aluminium profiles

The smooth surface of the aluminium profiles looks modern and elegant, unlike the ribbed profiles from other suppliers. Furthermore, a high-quality coating on the inside and outside of the door's surface makes it easy to clean. The hollow space of the profile is evenly filled with polyurethane rigid foam for quiet door travel.

Profile view of internal rolling shutters and garage horizontal doors

- 1 Inside of the door
- 2 Outside of the door

Profile view of external roller garage doors

- 1 Outside of the door
- 2 Inside of the door



Glazing elements ³

Get more daylight in your garage. The glazing elements with synthetic panes are arranged across the entire profile width. The number of elements depends on the respective door width. A maximum of ten profiles can be fitted with glazings in each door.

Ventilation grilles ⁴

Ventilation of your garage improves the room climate and prevents mould. Ventilation grilles made of long-lasting plastic are arranged across the entire profile width. Each door can be equipped with a maximum of ten profiles.



Please note:

With respect to their technical properties and the paint system used, all Hörmann roller garage doors correspond to the current state of the art. Pressure marks and abrasive wear are design-related and cannot be avoided. They do not impair the function and durability of the roller garage door.

In order to reduce the design-related wear on the door curtain to a minimum, we recommend using the optional DuraBelt winding unit (further information can be found on pages 26 and 30).

Decograin surface finish

A special abrasion-resistant surface protection preserves the UV-resistant plastic film coating on the profiles over a long time.

Profile view of internal rolling shutters and garage horizontal doors

- 1 Door interior in brown
- 2 Door exterior in Decograin Golden Oak



Decopaint surface finish

The interior and exterior of the profiles are painted to look like timber.

Profile view of internal rolling shutters and garage horizontal doors

- 3 Door interior in Decopaint Golden Oak
- 4 Door exterior in Decopaint Golden Oak

Profile view of external roller garage doors

- 3 Door exterior in Decopaint Golden Oak
- 4 Door interior in Decopaint Golden Oak



Colours and decors

Roller garage doors RollMatic, RollMatic T and garage horizontal door RollMatic OD

16 colours



Equally-priced standard colours

- | | | | | | |
|---|----------|-----------------|----|-----------------|-------------|
| 1 | RAL 9016 | Traffic white | 9 | RAL 7015 | Slate grey |
| 2 | RAL 9007 | Grey aluminium | 10 | RAL 6005 | Moss green |
| 3 | RAL 9006 | White aluminium | 11 | RAL 5011 | Steel blue |
| 4 | RAL 9005 | Jet black | 12 | RAL 3003 | Ruby red |
| 5 | RAL 9001 | Cream | 13 | RAL 3004 | Purple red |
| 6 | RAL 8028 | Terra brown | 14 | RAL 1015 | Light ivory |
| 7 | RAL 7035 | Light grey | 15 | Chartwell Green | |
| 8 | RAL 7016 | Anthracite grey | | | |

Special colour

- | | |
|----|-----------------|
| 16 | Noir 2100 Sablé |
|----|-----------------|

Please note:

All colours based on RAL. The colours and surface finishes shown are subject to the limitations of the printing process and cannot be regarded as binding. Please consult with your local Hörmann specialised dealer.

Decograin surface finish

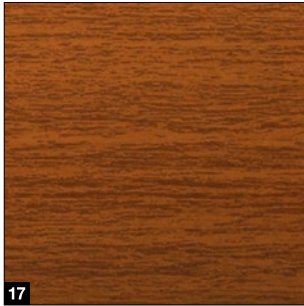

17

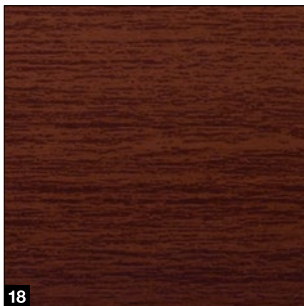

18

Decopaint surface finish



19

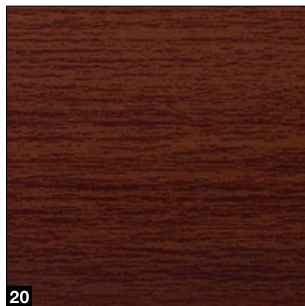

20

17 Decograin Golden Oak

18 Decograin Rosewood

19 Decopaint Golden Oak

20 Decopaint Rosewood

Harmonious overall appearance in 16 colours

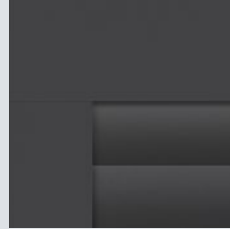

At Hörmann, we offer the door curtain, booms, fascia panel and shaft cover in the door colour selected at no surcharge.

Fitting variants with Decograin surface finish

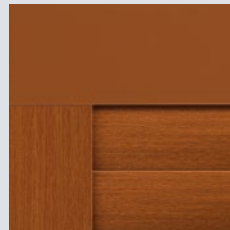

Roller garage door RollMatic fitting in the opening

Profile and booms in Decograin, fascia panel in the base colour of the decor and additional fascia panel in Decograin (see page 37).

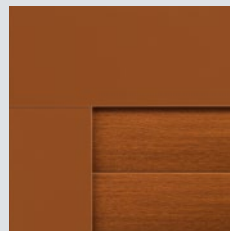

Roller garage door RollMatic fitting behind the opening

Profile in Decograin, fascia panel and booms in the base colour of the decor

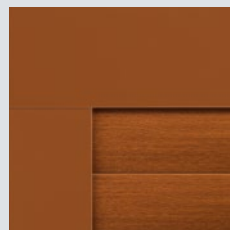

Garage horizontal door RollMatic OD Fitting in the opening or behind the opening

Profile in Decograin, fascia panel and booms in the base colour of the decor

Fitting variants with Decopaint surface finish

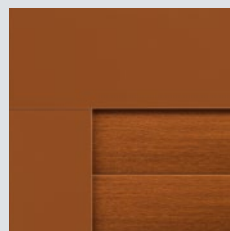

Roller garage door RollMatic / garage horizontal door RollMatic OD

Profile in Decopaint, fascia panel and booms in the base colour of the decor

Roller garage door RollMatic

With patented tension spring technology



Only from Hörmann

Roller garage door with tension spring assembly



Only from Hörmann

Wear-resistant bearing rings

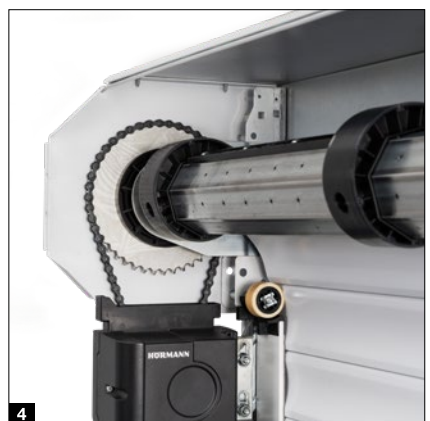
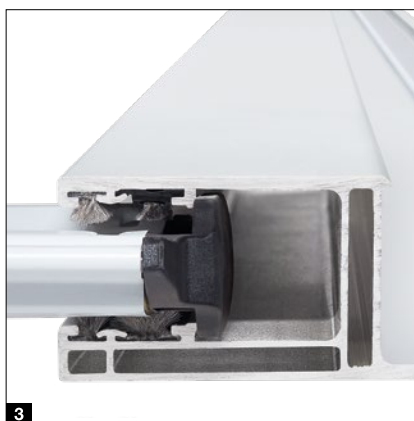

A well-protected barrel

The standard cover **1** of the barrel effectively prevents reaching into the door barrel. In addition, it protects the curtain from damage and soiling when the door is open.

Reliable counterbalance

The patented tension spring assembly with spring-in-spring system **2** and the transparent protective cover prevent broken springs from flying out and thus protect from personal injury.

Secure curtain guide

The standard wind locks **3** in the profile ends keep the door securely in the guide even under high wind loads (up to class 4) and also offer increased burglar protection.

Fewer design-related marks

The use of wear-resistant materials reduces marks of the bearing rings **4** on the top door curtain profiles.

In addition, the rollers are positioned above the boom, so that the design-related roller marks on the curtain are less visible.

Additional surface protection

With the optional DuraBelt **5**, your door remains beautiful longer. When rolling up, several belts are placed between the individual layers of the door curtain, thus significantly reducing scratch marks caused by soiling of the door curtain.

The DuraBelt can also be retrofitted to all internal and external roller garage doors.

Easy fitting

The booms, fascia panel and operator are fitted to the garage walls and lintel. The curtain is then pulled effortlessly onto the barrel by the operator and fixed via belts **6**.

Size range

Max. width 6000 mm
Max. height 3100 mm

External roller garage door

Depending on the fitting situation, operators can either be installed on the left or right. The shaft cover is 100 mm wider in this area and encloses the operator **7**, protecting it from adverse weather effects or from unauthorised interference. The vision fields **8** in the spring cover allow you to conveniently check whether the cable guide or springs are still functional. This gives you security even after many years of use.

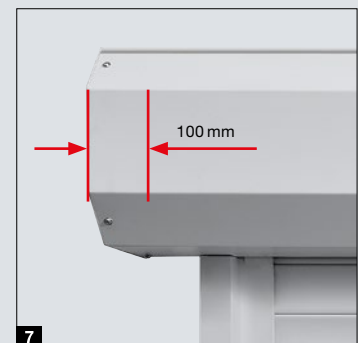
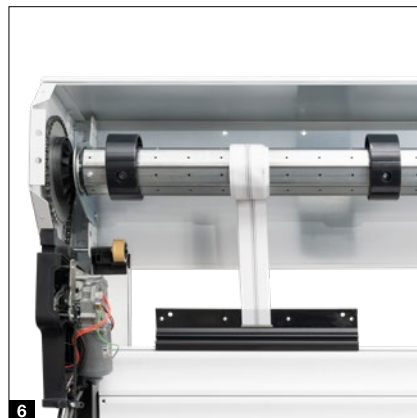
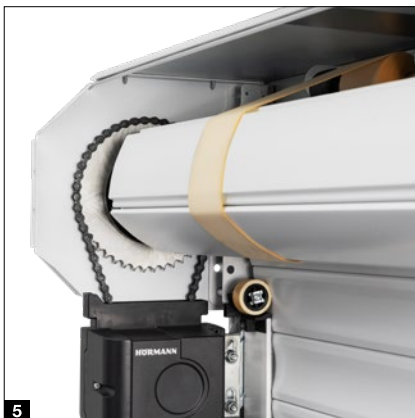

Roller garage door RollMatic

Operator and control RollMatic 2

Standard operator, fitted outside of the cover for trouble-free maintenance

- 20% faster opening speed* up to 17 cm/s
- Smart operation with the BlueSecur app
- Control with “Open / Close” buttons for inside operation
- Easy-to-use programming thanks to 2 × 7-segment display
- Networked with Smart Home systems via the standard HCP interface
- Bright LED lighting
- Low power consumption in standby below 1 watt
- Electronic end-of-travel position cut-out to protect the curtain surface
- Convenient garage ventilation
- Additional opening height



BiSecur

4-button hand transmitters HSE 4 BS, black textured surface with plastic caps as standard

Garage door operators

Bluetooth receiver	Integrated, can be switched on and off
HCP bus connection	Integrated
Cycles per day / hour	25 / 10
Max. opening speed	17 cm/s
Lighting	10 LEDs
Max. door width	6000 mm
Max. door surface	15 m ²

* Compared to series 1

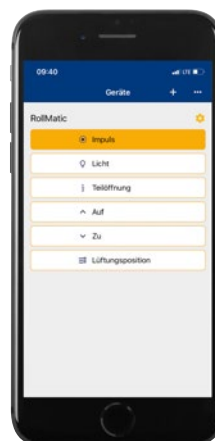

Only from Hörmann
European patent

Hörmann BlueSecur

Operation by smartphone using the Hörmann BlueSecur app

Closing edge safety device

An optosensor in the bottom seal **1** reliably stops the door in the event of an unexpected obstacle – optional for doors up to 5000 mm wide and standard for doors from 5000 mm.

Emergency release from inside

Release the operator conveniently from the inside, e.g. to open the door manually from the inside in the event of a power failure. With internal rolling shutters, the manual is operated directly on the operator. With external roller garage doors, actuation takes place via a release from the inside.

Emergency release from outside (optional)

For garages without a second entrance, we recommend the secured release in a lockable housing **2**, allowing you to open your garage door from the outside in case of an emergency (e.g. power failure).

Emergency power supply (optional)

With the emergency battery **3**, you can bridge network power failures for up to 18 hours and max. 5 door cycles. Recharges during normal operation.

Acoustic alarm (optional)

The shrill alarm sound with a volume of 110 dB (A) effectively deters burglars.

Manually operated door with manual door locking

Thanks to the supporting tension spring compensation, Hörmann roller garage doors are easy to manually open and close from the outside of the garage using the handle **4** and from the inside with the chain tensioner **5**. The manually operated roller garage door is mechanically locked using interior and exterior handles and a lock. Solid metal bolts extend on the right and left into the side guides.



Roller garage door RollMatic T

With space-saving tubular operator



Only from Hörmann
DuraBelt



A well-protected barrel

The standard cover **1** of the barrel effectively prevents reaching into the door barrel. In addition, it protects the curtain from damage and soiling when the door is open.

Space-saving construction

The compact door construction with tubular operator has a required headroom of only 290 mm and sideroom of only 75 mm (up to 2300 mm door height) or 105 mm (from 3001 mm door width) and is also suitable for particularly narrow fitting situations. The booms **2** ensure smooth door travel and are optimally sealed by the standard brush seals.

Additional surface protection

With the optional DuraBelt **3**, your door remains beautiful longer. When rolling up, several belts are placed between the individual layers of the door curtain, thus significantly reducing scratch marks caused by soiling of the door curtain. The DuraBelt can also be retrofitted to all internal and external roller garage doors.

Easy fitting

The pre-assembled barrel incl. cover and the pre-drilled booms with standard backfill are quickly and easily screwed to the garage walls and lintel.

Emergency operation as standard

Even in the event of a power failure, you can easily open the RollMatic T from the inside using the standard emergency crank handle. With optional external emergency operation **4**, a crank handle is inserted into a lockable opening that opens the door from the outside.

Space-saving tubular operator

The powerful tubular operator is equipped with mechanically adjustable end-of-travel positions. Optionally, the operator is also available with electronic end-of-travel position cut-out. The operator can be controlled from the inside with the stylish control. The integrated LED lighting provides more light in the garage.

Closing edge safety device as standard

An optosensor in the bottom seal reliably stops the door in the event of an unexpected obstacle. The standard version is available with spiral cable **5** or optionally with radio transmission **6** and without spiral cable.



BiSecur

4-button hand transmitters HSE 4 BS, black textured surface with plastic caps as standard

Garage horizontal door RollMatic OD

Ideal for modernisation

Smooth door travel

Twin rollers evenly and smoothly guide the door curtain under the ceiling. The narrow aluminium booms are connected by stable corner diversions with small radii **1**. Due to this compact design, the garage horizontal door RollMatic OD only requires a lintel of 60 mm.

Well-sealed

The door is almost completely closed in the lintel area thanks to the specially shaped folding roller bracket **2**. An elastic lip seal in the lintel area and brush seals in the booms protect against driving rain (class 2). The flexible EPDM bottom profile compensates for unevenness in the floor and seals the bottom edge of door.

Reliable counterbalance

The multiple spring assemblies and integrated catch safety device **3** protect the door from crashing in the event of a possible cable tear.

Additional emergency release

We recommend using an optional emergency release lock **4** for garages without a second entrance. An inconspicuous round cylinder (cannot be integrated in the master key system) releases your garage door and you can easily open it in case of emergency.

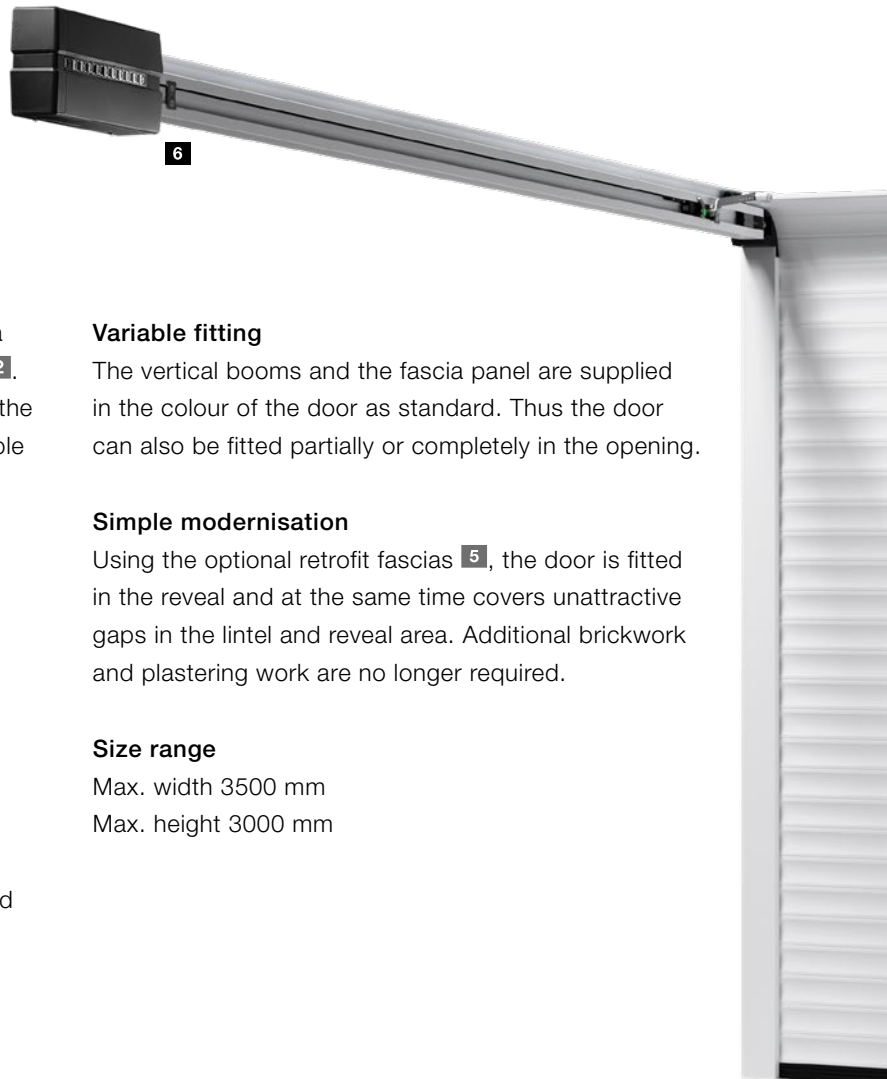

Variable fitting

The vertical booms and the fascia panel are supplied in the colour of the door as standard. Thus the door can also be fitted partially or completely in the opening.

Simple modernisation

Using the optional retrofit fascias **5**, the door is fitted in the reveal and at the same time covers unattractive gaps in the lintel and reveal area. Additional brickwork and plastering work are no longer required.

Size range

Max. width 3500 mm

Max. height 3000 mm





Space-saving operator fitting*

The operator booms **6** can either be fitted on the right or the left horizontal boom. This compact design does not require additional headroom.

Emergency power supply

The emergency battery HNA* **7** for garage door operators ProMatic and SupraMatic bridges network power failures for up to 18 hours and a maximum of 5 door cycles. Recharges during normal operation.

* Shown with optional operator SupraMatic

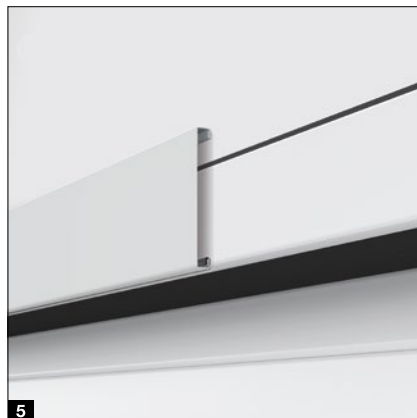

Garage horizontal door RollMatic OD

ProMatic 4 operator

Standard operator in premium quality

- 40% faster opening speed* up to 20 cm/s
- Convenient garage ventilation
- Additional opening height
- Up to 2 times* brighter LED lighting
- Networked with Smart Home systems via the standard HCP interface
- Low power consumption in standby below 1 watt



 **BiSecur**

4-button hand transmitters HSE 4 BS, black textured surface with plastic caps as standard

Garage door operators	ProMatic 4	ProMatic 4 Akku
Bluetooth receiver	Optional (HET-BLE)	Optional (HET-BLE)
HCP bus connection	Integrated	Integrated
Cycles per day / hour	25 / 10	5 / 2
Pull and push force	600 N	500 N
Peak force	750 N	600 N
Max. opening speed	20 cm/s ¹⁾	16 cm/s ¹⁾
Lighting	10 LEDs	10 LEDs

* In comparison with the ProMatic series 3

ProMatic 4 Akku

For garages without power connection



Akku with solar module

Garage horizontal door RollMatic OD

SupraMatic 4 operator

Supra-fast door opening and smart additional functions

- 75% faster opening speed* up to 25 cm/s
- Smart operation with the BlueSecur app
- Convenient garage ventilation
- Additional opening height
- Up to 3 times (SupraMatic E) or 5 times* (SupraMatic P) brighter LED lighting
- Easy-to-use programming thanks to 2 x 7-segment display
- High-quality stainless steel operator cover
- Networked with Smart Home systems via the standard HCP interface
- Low power consumption in standby below 1 watt



BiSecur

4-button hand transmitters HSE 4 BS, black textured surface with chrome caps as standard

Garage door operator	SupraMatic E
Bluetooth receiver	Integrated, can be switched on and off
HCP bus connection	Integrated
Cycles per day / hour	25 / 10
Pull and push force	650 N
Peak force	800 N
Max. opening speed	25 cm/s
Lighting	20 LEDs

* In comparison with the ProMatic series 3

Only from Hörmann
European patent

Hörmann BlueSecur

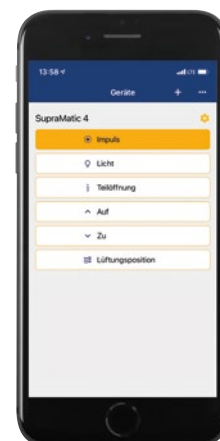

Operation by smartphone using the Hörmann BlueSecur app

Optional extras

Roller garage doors RollMatic and RollMatic T

Chamfered bottom profile

(only for RollMatic)

The solution for sloping ground: a chamfered aluminium bottom weather seal compensates for differences in height over the entire door width (max. 300 mm).

The profile can be fitted without any difficulty. It is simply screwed onto the inserted curtain.

The bottom profile is delivered powder-coated in Jet black (similar to RAL 9005) as standard. On request, the bottom profile **1** is also available in a colour matching the door colour.

Additional fascia panel

The additional fascia panel **2** stabilises the fascia panel when fitted in the opening or behind the opening if the fascia panel is visible in the opening. It harmoniously covers the lintel without any unattractive fitting holes.

The additional fascia panel is available in the door colour or with Decograin surface finish.

Fitting compensation set

With uneven walls, the optional fitting compensation set **3** for flush door fitting can be applied. This is particularly advantageous for modernisations or timber building structures.

For more information, consult the technical manual at www.hoermann.de

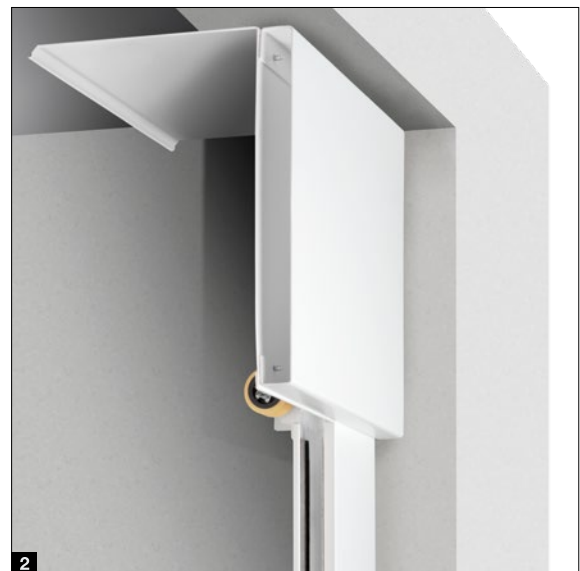



Door sizes

- Width 875 – 1284 mm
- Height 1800 – 2500 mm

Standard equipment

- 60 mm thick weather-resistant aluminium profiles in the colour of the profiles or, in the case of Decopaint, in a colour matching the decor **1**
- Black plastic lever handle set with oval rose escutcheons and profile cylinder lock **2**
- 3-way adjustable hinges **3** optionally in black, white or aluminium natural finish

Optional equipment

- Concealed hinges for an elegant door appearance **4**
- Lever handle or lever / knob handle sets in aluminium natural finish **5**, cast aluminium RAL 9016 **6**, brushed stainless steel **7**
- Overhead door closer with slide rail and hold-open device
- 3-point locking (latch, bolt and 2 locking hooks)

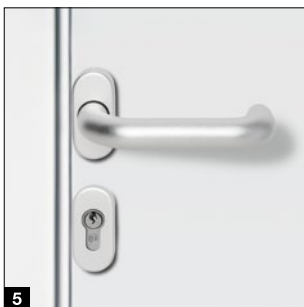

Accessories

Hand transmitter



HS 5 BS
4 button functions, plus query button, high-gloss surface black or white



HS 5 BS
4 button functions, plus query button, textured surface matt black



HS 4 BS
4 button functions, textured surface matt black



HS 1 BS
1 button function, textured surface matt black



HSE 1 BS
1 button function, including eyelet for key ring, textured surface matt black



HSE 4 BS
4 button functions, incl. eyelet for key ring, textured surface matt black with chrome or plastic caps



HSE 4 BS
4 button functions, incl. eyelet for key ring
High-gloss surface with chrome caps, colours (shown from left): White, Anthracite grey, Frozen grey, Classic grey, Carbon, Silver



HSD 2-C BS
High-gloss chrome, 2 button functions, can also be used as a key ring



HSZ 1 BS / HSZ 2 BS
1 or 2 button functions, for insertion in vehicle cigarette lighter



HSI 3 BS .NEW
To control up to 3 doors, with extra-large buttons, impact-resistant housing, protection category: IP 65

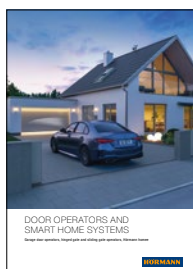

Further information can be found in the "Door operators and Smart Home systems" brochure.



**Radio code switch
FCT 3 BS**

3 functions, with illuminated buttons, recessed or surface-mounted fitting possible, plastic housing in Light grey RAL 7040 (also available with 10 functions and hinged cover, painted in White aluminium RAL 9006)



**Radio code switch
FCT 10 BS**

10 functions, with illuminated buttons and hinged cover, recessed or surface-mounted fitting possible, plastic housing painted in White aluminium RAL 9006



**Radio finger-scan
FFL 25 BS**

2 functions and up to 25 fingerprints, with hinged cover, recessed and surface-mounted fitting possible, plastic housing painted in White aluminium RAL 9006



**Radio internal push button
FIT 5 BS**

4 button functions plus query button, plastic housing in Pure white RAL 9010

Button



**Radio internal push button
FIT 2-1 BS**

2 functions, connection option for max. 2 control elements via cable, e.g. key switch, plastic housing in Pure white RAL 9010



**Internal push button
IT 1b-1**

Large, illuminated button for convenient opening of the door, plastic housing in Pure white RAL 9010



**Transponder key switch
TTR 1000-1**

1 function, 1000 teachable keys, scope of delivery: 1 key and 1 card (more on request), zinc die-cast housing in White aluminium RAL 9006



**Code switch
CTP 3-1**

3 functions, with illuminated lettering and touch-sensitive black surface, zinc die-cast housing in White aluminium RAL 9006



**Code switch
CTV 3-1**

3 functions, particularly robust with metal keypad, zinc die-cast housing in White aluminium RAL 9006 with stainless steel panel



**Finger-scan
FL 150**

2 functions, control via fingerprint, up to 150 savable fingerprints, zinc die-cast housing in White aluminium RAL 9006 with stainless steel panel



**Key switch
1 STUP 50
2 STAP 50**

Recessed version and surface-mounted version, incl. 3 keys, zinc die-cast housing in White aluminium RAL 9006 with stainless steel panel



**Internal climate sensor HKSI 3
External sensor HKSA 4**

For monitoring humidity and automatic ventilation of the garage, plastic housing in Pure white RAL 9010

For measuring outdoor humidity, plastic housing in Pure white RAL 9010

Dimensions and technical manual

Roller garage door RollMatic

Internal rolling shutter

Fitting behind the opening, view of fitting side

Internal rolling shutter

Fitting in the opening, interior view

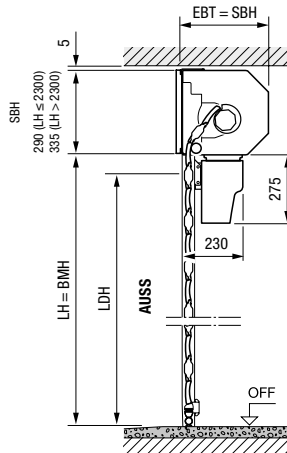
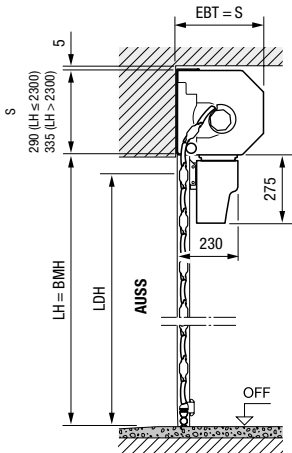
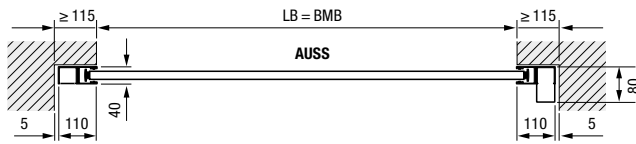
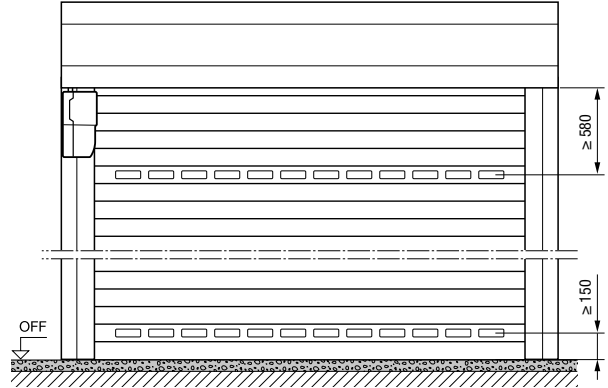
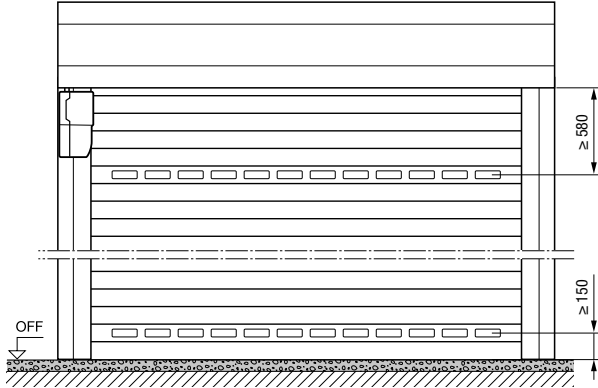

An additional fascia panel is required!

Size range for internal and external roller garage doors

Clear height (LH)	1000	1250	1500	1750	1900	2000	2250	2500	2750	3000	3250	3500	3750	4000	4250	4500	4750	5000	5250	5500	5750	6000	
3100																							
3000																							
2875																							
2750																							
2675																							
2625																							
2500																							
2375																							
2250																							
2125																							
2000																							
1800																							
1600																							

- Internal rolling shutters
- External roller garage doors

Dimensions in mm

External roller garage door

Fitting in front of the opening, view of fitting side

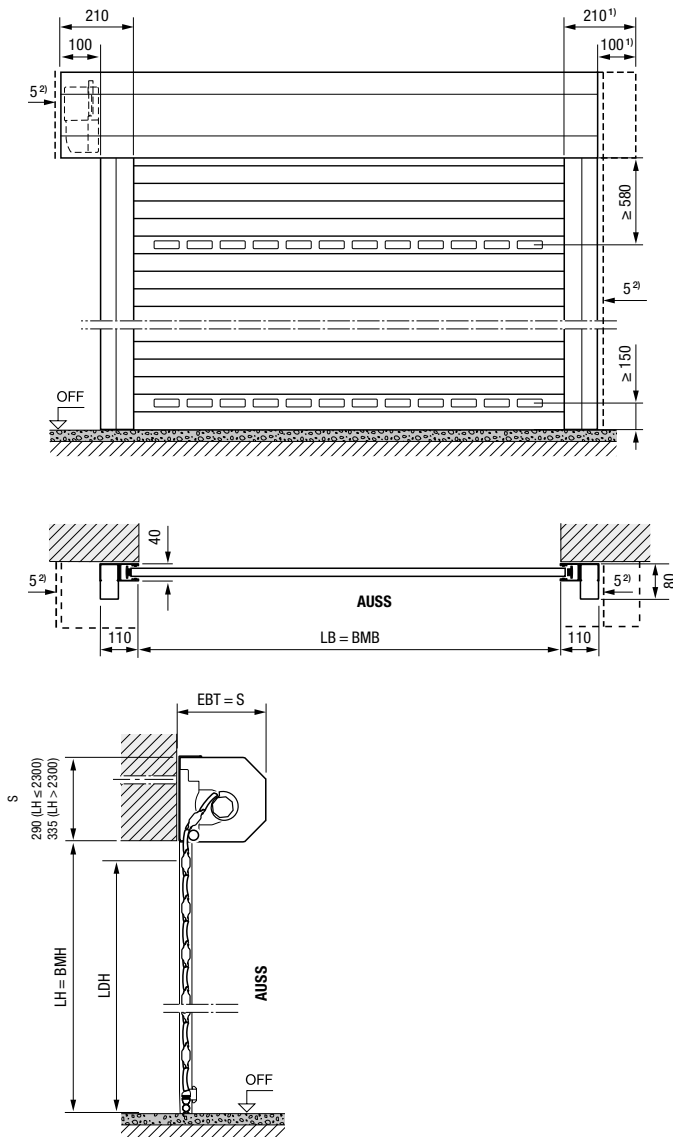

Explanations

BMB	Ordering size width
BMH	Ordering size height
LB	Clear width
LH	Clear height
LDB	Clear passage width
LDH	Clear passage height
EBT	Fitting depth
S	Required headroom
SBH	Additional fascia panel height
OFF	Finished floor level
AUSS	Exterior

Fitting depth EBT

Up to LH = 2300 mm	290 mm
From LH = 2301 mm	335 mm

Required headroom S / additional fascia panel SBH

Up to LH = 2300 mm	290 mm
From LH = 2301 mm	335 mm

Clear passage height LDH

With operator	LH - 100 mm
Manually operated	LH - 125 mm

Side space requirement

External roller garage door	115 mm
operator side	215 mm

Wind load classes

Up to LB = 3000 mm	Class 5
Up to LB = 4000 mm	Class 4
Up to LB = 4500 mm	Class 3
From LB = 4500 mm	Class 2

Water tightness under heavy rain

Class 2

- ¹⁾ For a visually balanced look the curtain cover can be ordered symmetrically!
- ²⁾ At least 5 mm distance from fascia panel / boom

Dimensions in mm

Dimensions and technical manual

Roller garage door RollMatic T

Internal rolling shutter

Fitting behind the opening, view of fitting side

Internal rolling shutter

Fitting in the opening, interior view

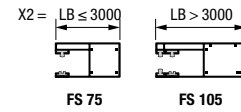
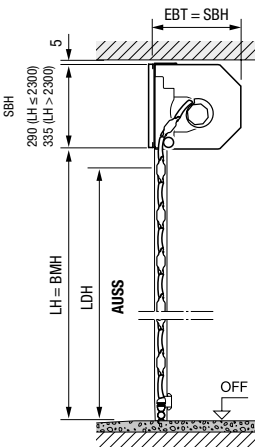
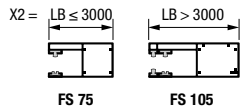
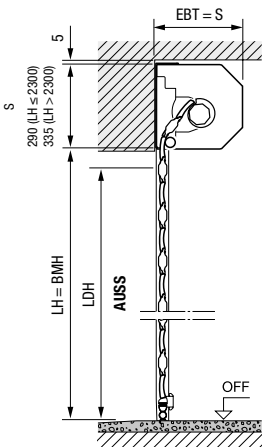
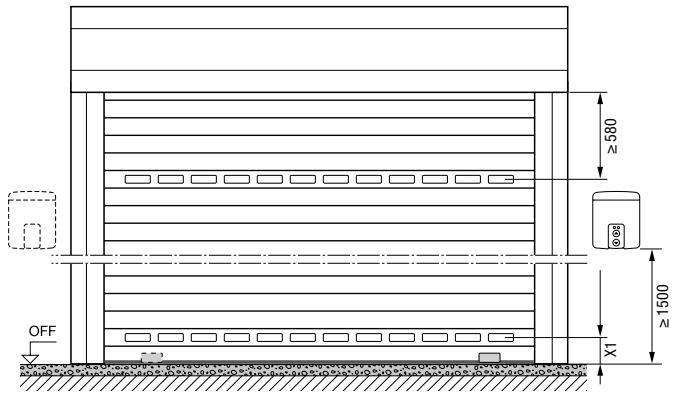
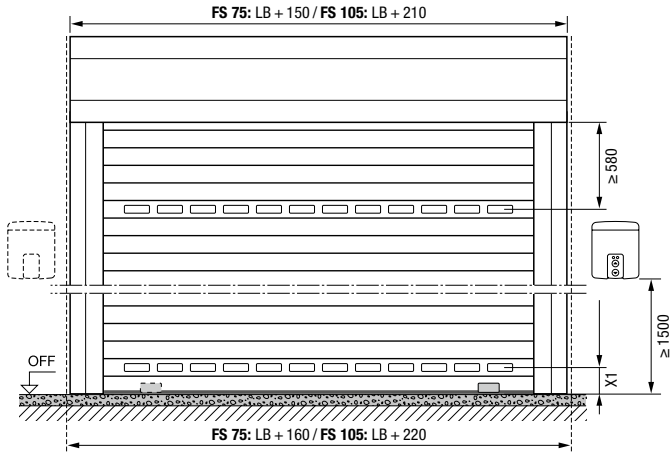

An additional fascia panel is required!

Size range for internal and external roller garage doors

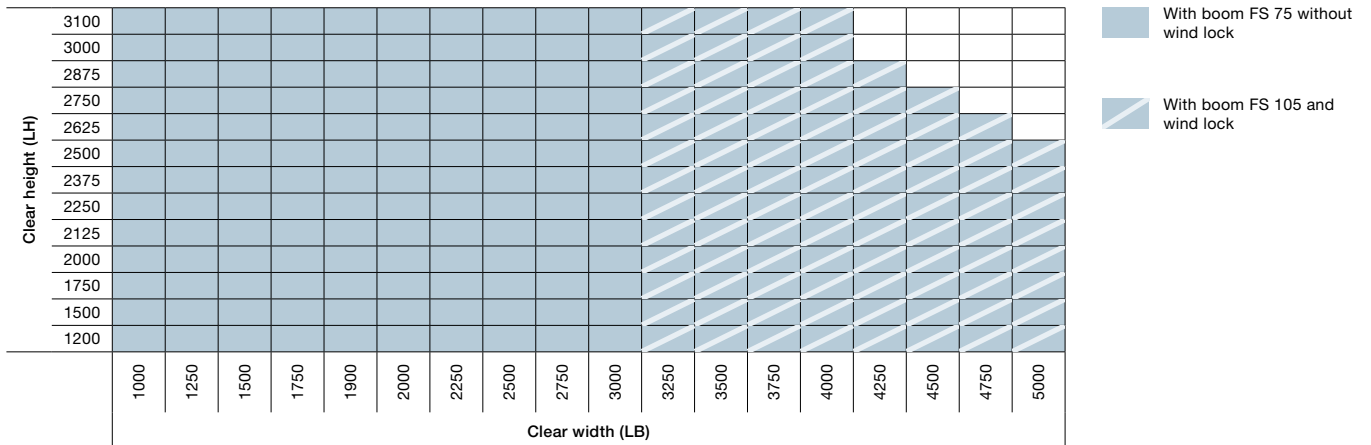

Dimensions in mm

External roller garage door

Fitting in front of the opening, view of fitting side

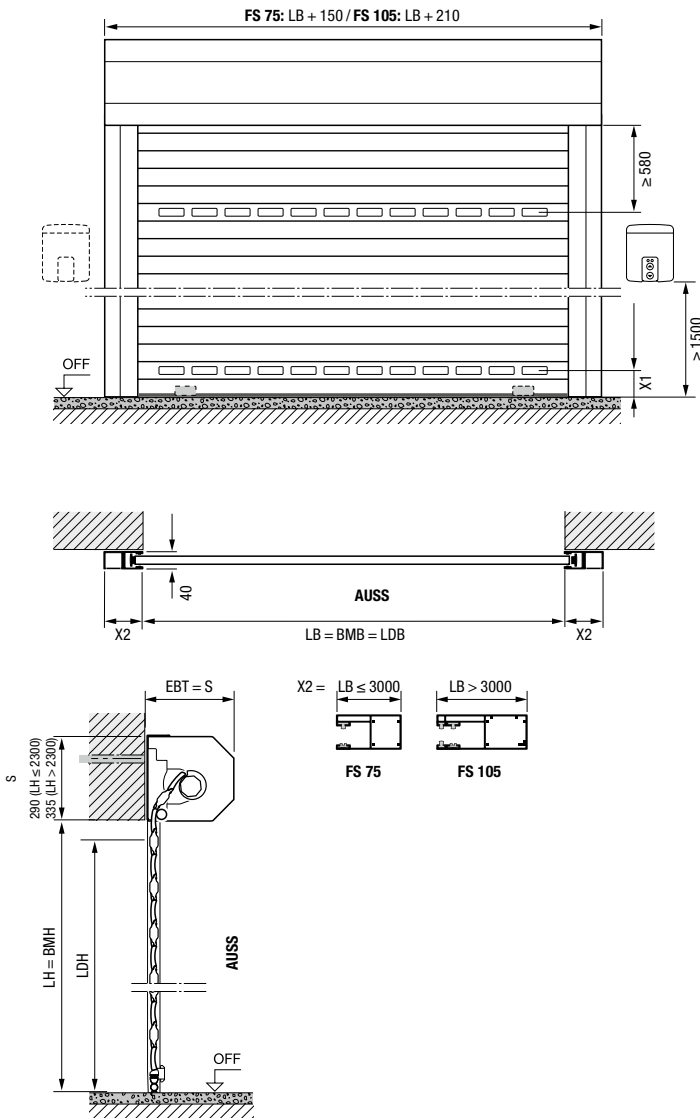

Additional fascia panel

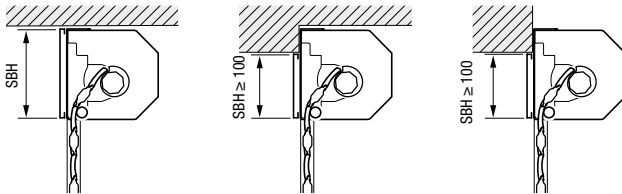

Internal rolling shutter

Fitting in the opening

Internal rolling shutter

Fitting behind the opening, fascia panel protrudes into the opening

External roller garage door

Fitting in front of the opening, fascia panel protrudes into the opening

Dimensions in mm

Explanations

- BMB** Ordering size width
- BMH** Ordering size height
- LB** Clear width
- LH** Clear height
- LDB** Clear passage width
- LDH** Clear passage height
- EBT** Fitting depth
- S** Required headroom
- SBH** Additional fascia panel height
- OFF** Finished floor level
- AUSS** Exterior
- X1** Min. 150 mm
- X2** LB ≤ 3000 = 75 mm (FS 75)
LB > 3000 = 105 mm (FS 105)

Fitting depth EBT

Up to LH = 2300 mm	290 mm
From LH = 2301 mm	335 mm

Required headroom S / additional fascia panel SBH

Up to LH = 2300 mm	290 mm
From LH = 2301 mm	335 mm

Clear passage height LDH

FS 75	LH - 70 mm
FS 105	LH - 110 mm

Side space requirement

Up to LB = 3000 mm	80 mm
From LB = 3001 mm	110 mm

Wind load classes

Without wind lock

Up to LB = 3000 mm	Class 3
--------------------	---------

With wind lock

Up to LB = 4000 mm	Class 4
Up to LB = 4500 mm	Class 3
Up to LB = 5000 mm	Class 2

Dimensions and technical manual

Garage horizontal door RollMatic OD

Garage horizontal door

Fitting behind the opening, view of fitting side

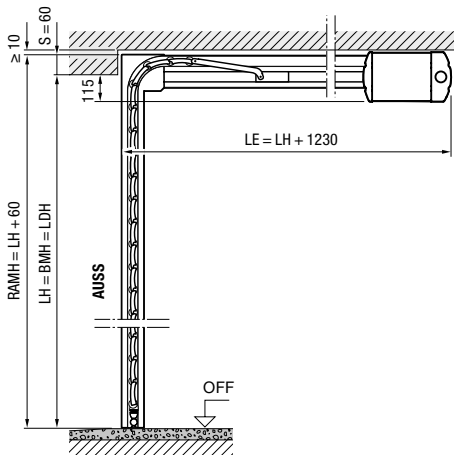
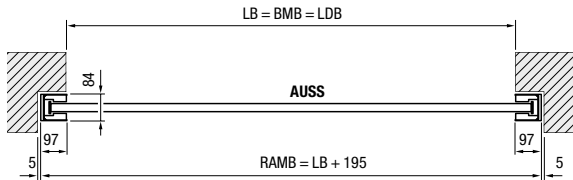
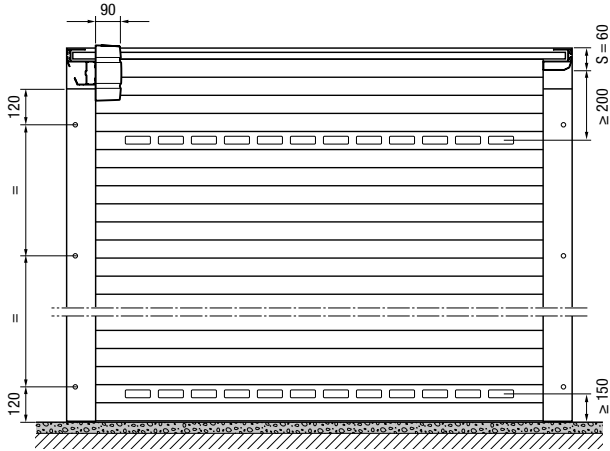

Garage horizontal door

Fitting in the opening, interior view

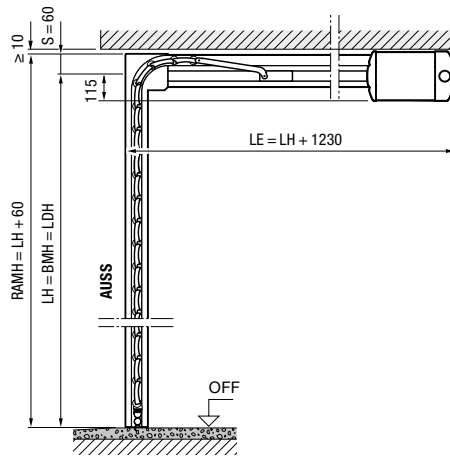
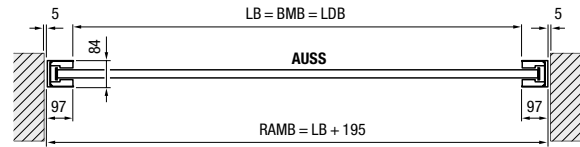
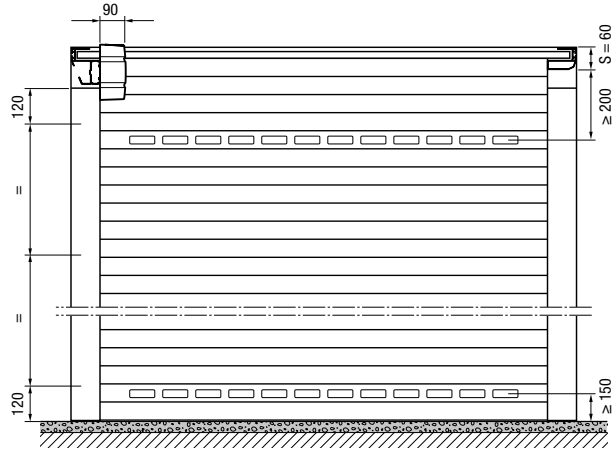

Size range for garage horizontal door RollMatic OD*

Clear height (LH)	3000									
	2875									
	2750									
	2625									
	2500									
	2375									
	2250									
	2125									
	2000									
	1875									
	1700									
		1250	1500	1750	2000	2250	2500	2750	3000	3250
	Clear width (LB)									

* Flush-fitting in the opening with panel 95:
LB ≤ 3150 mm, LH ≤ 2700 mm

Dimensions in mm

Garage horizontal door

Flush-fitting in the opening with panel 95

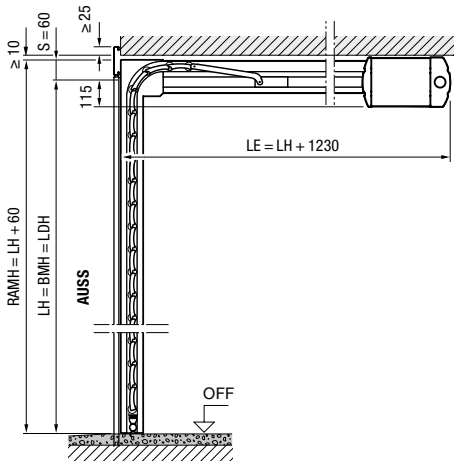
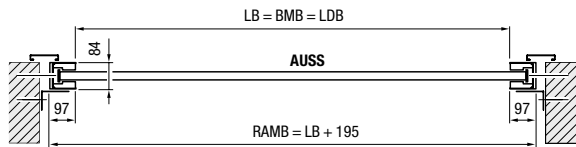
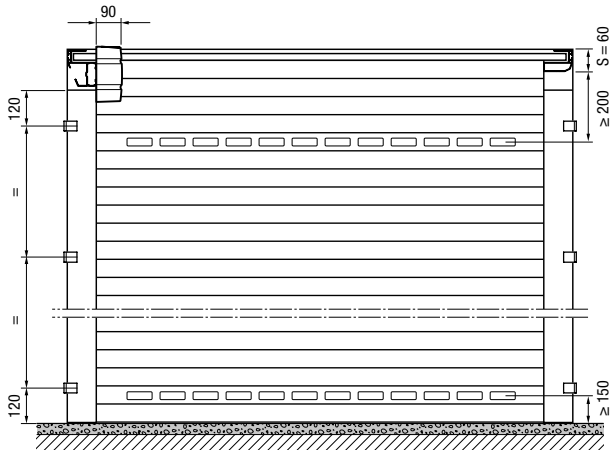

Explanations

- BMB** Ordering size width
- BMH** Ordering size height
- LB** Clear width
- LH** Clear height
- LDB** Clear passage width
- LDH** Clear passage height
- RAMB** Overall frame dimension width
- RAMH** Overall frame dimension height
- LE** Distance back with operator
- S** Required headroom
- OFF** Finished floor level
- AUSS** Exterior

Side space requirement 102 mm

Wind load classes

- Up to LB = 3000 mm Class 3
- Up to LB = 3500 mm Class 2

Water tightness under heavy rain

Class 2

Dimensions in mm

Dimensions and technical manual

Side doors

Side door with block frame

Fitting behind the opening, opening inwards

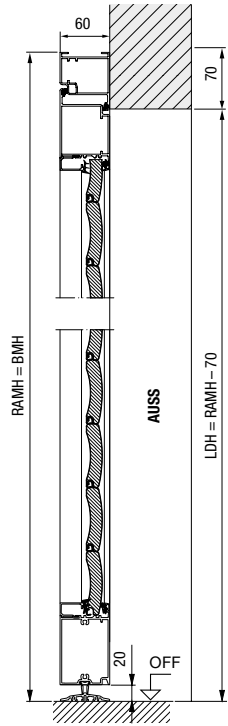

Side door with block frame

Fitting in the opening, opening inwards

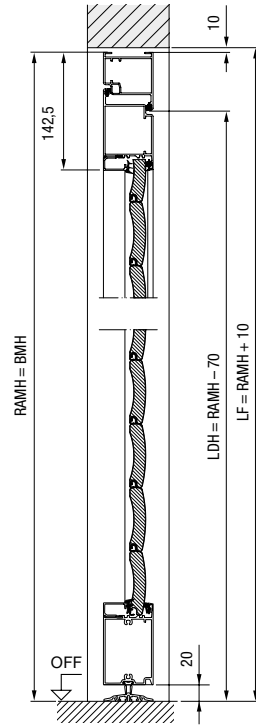

Side door with block frame

Fitting in the opening, opening outwards

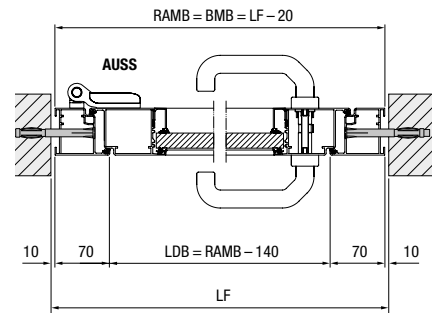
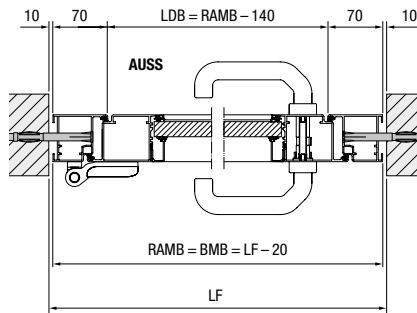
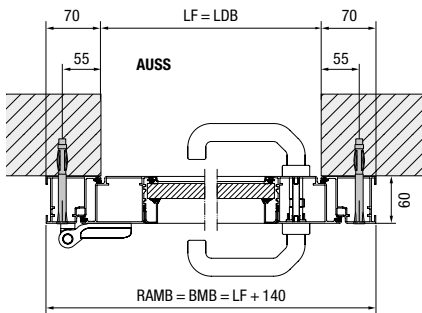
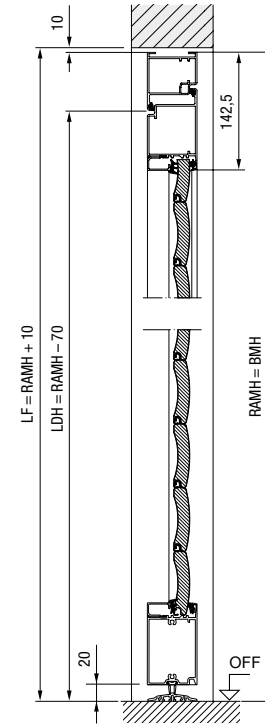

Dimensions in mm

Side door with corner frame

Internal fitting opening inwards

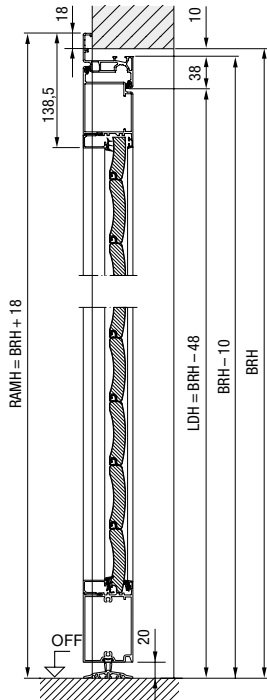

Side door with corner frame

External fitting opening outwards

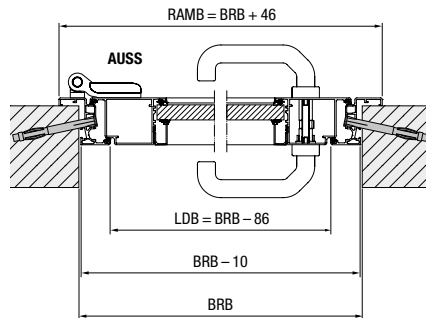
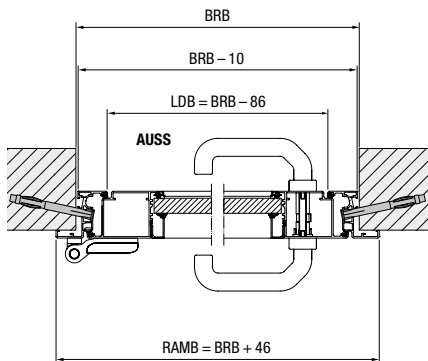
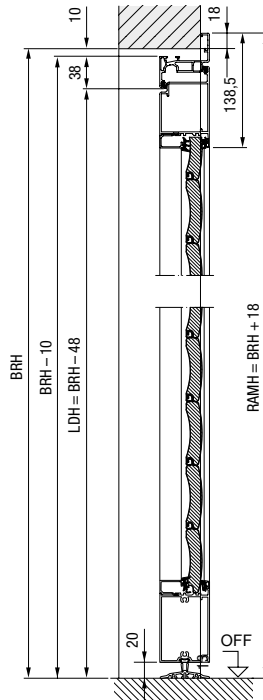

Explanations

- BRB** Nominal size width
- BRH** Nominal size height
- BMB** Ordering size width
- BMH** Ordering size height
- LDB** Clear passage width
- LDH** Clear passage height
- LF** Structural opening
- RAMB** Overall frame dimension width
- RAMH** Overall frame dimension height
- OFF** Finished floor level
- AUSS** Exterior

Material

Door leaf frame made of extruded aluminium profiles with roller garage door section infill, position of the sections does not match roller garage door RollMatic, use of glazing and ventilation grille corresponds with roller garage door RollMatic.

Dimensions in mm

Experience Hörmann quality in new construction and modernisation

Hörmann products have impressive durability and high functionality. You can easily plan for new construction as well as modernisation. The carefully coordinated solutions make your home more beautiful, more secure and more comfortable.

**GARAGE DOORS. GATE AND DOOR OPERATORS. ENTRANCE DOORS.
RESIDENTIAL INTERNAL DOORS. STEEL DOORS. FRAMES. STORAGE SPACE SYSTEMS.**



Some of the products shown are equipped with special equipment and do not always correspond to the standard versions. The surface finishes and colours shown are subject to the limitations of the printing process and cannot be regarded as binding. All rights reserved. No part may be reproduced without our prior permission. Subject to changes.