



# THERMO65 / THERMO46 ENTRANCE DOORS

**NEW.** Double-leaf entrance door Thermo65

**HÖRMANN**





04

Good reasons  
to try Hörmann  
entrance doors.



14

Door styles.  
Inspirations.



28

Design.  
Equipment.  
Accessories.

# Responsibility for generations

The Hörmann family business has over 85 years of experience as a construction component specialist. This gives us an obligation to both current and future generations. That's why environmental responsibility plays such an important role for us. With this in mind, we develop innovative solutions for sustainable products and intelligent environmental protection.



## “A GOOD REPUTATION MUST BE EARNED.”

August Hörmann

In keeping with the tradition started by the company’s founder, the Hörmann brand is a true promise of quality and, with sales of over 20 million doors and operators, is one of Europe’s most successful suppliers. Due to the comprehensive international sales and service network, Hörmann is your strong partner for high-quality construction components.



**WE THINK AND ACT GREEN.** As a family business, we are very conscious of our responsibility to future generations. The Hörmann climate protection strategy aims to reduce and avoid CO<sub>2</sub> emissions. We cover 100% of our electrical power needs at all European production locations with purchased green electricity. We are also investing in a clean future with other measures such as the use of recycled paper, CO<sub>2</sub>-neutral postal shipping and the recycling of transport packaging to save more than 75,000 tons of CO<sub>2</sub> every year. We work with ClimatePartner to offset the emissions that we do generate by supporting certified climate protection projects. In particular, we offset all CO<sub>2</sub> emissions produced in manufacture of products for residential construction as standard. Products for construction projects are also available as CO<sub>2</sub>-neutral versions upon customer request.



You can find further information at [www.hoermann.com/sustainability](http://www.hoermann.com/sustainability)



**ClimatePartner**  
**certified product**  
[climate-id.com/XNEBKC](http://climate-id.com/XNEBKC)



CO<sub>2</sub>  
measure  
reduce  
contribute



**ClimatePartner**  
**certified product**  
[climate-id.com/FYZNUF](http://climate-id.com/FYZNUF)



CO<sub>2</sub>  
measure  
reduce  
contribute

# Brand quality made in Germany



The family-owned company Hörmann offers all important construction components for building and renovating projects from a single source. We manufacture in highly specialised factories using state-of-the-art production technologies. Our employees work intensively on new products, continual further developments and improvements to details. The results are patents and unique products on the market.





**5-year  
warranty**

**LONG-LASTING. GUARANTEED.** All major door components are developed and manufactured by Hörmann. Endurance tests under real conditions ensure mature series products with Hörmann quality. Thanks to this and uncompromising quality assurance, you receive a 5-year warranty on all Hörmann entrance doors Thermo65 / Thermo46.



**CONVINCING IN EVERY VERSION.** Our entrance doors are superior to plastic or timber doors in many ways. When it comes to thermal insulation, all of our entrance doors meet the requirements of the new German Buildings Energy Act (GEG). Our acoustic-rated doors also reduce street noise to room level and our fire-rated doors are the ideal choice for between the garage and your living space.

→ For further information, see from page 30.



# Door design for the highest demands

Greet your guests with a Hörmann entrance door! And of course, you and your family can also delight in the sophisticated design of our doors day after day. Our doors are a true eye-catcher on the outside, and inside they harmonise perfectly with your residential internal doors. Simply beautiful!







**DOOR LEAF WITHOUT VISIBLE LEAF PROFILE.**

Thermo65 and Thermo46 doors make for an exquisite and elegant reception – whether you use them for your main or a side entrance. The stylish door leaf with its solid interior and exterior and leaf profile on the inside fulfils the highest design requirements. The interior view harmonises perfectly with your residential internal doors.

TOP. Exterior and interior view of Hörmann entrance doors without visible leaf profile

BOTTOM. Exterior and interior view of entrance doors from other manufacturers with visible leaf profile

PAGE 8. Steel / aluminium entrance door Thermo65 style 515, stainless steel handle HB 38-2, Matt deluxe Grey aluminium CH 9007, optional side elements

# We protect you from unwanted visitors

An apartment is broken into every five minutes, making it even more important to equip your entrance door with a high security standard. If a burglar is not successful within approx. 90 seconds, they generally give up their break-in attempt. For this reason, nearly half of all break-in attempts fail if the entrance door is break-in-resistant.





**BREAK-IN-RESISTANT LOCKING.** For you and your family, being able to rest easy in your own home is important. This is why our Thermo65 / Thermo46 doors are equipped with multiple-point locking as standard. And with the standard soft lock latch, the doors also close very quietly.



**RC2 security**  
Optional



**Tested and certified**

**FOR INCREASED SECURITY.** With the optional RC2 security features, our entrance doors make it especially difficult for burglars to break into your home. This protects your home from break-in attempts. Additionally, the certified security features are not visible on the door, unlike with many competitor solutions.

→ For further information, see from page 30.

# Entrance doors tailored to your specifications

Whether you want a new entrance door or a door for you side entrance: The Hörmann range is designed to meet your needs. We offer you doors tailored to your exact wishes. Whether with an elegant look, large glazings or intelligent operating comfort – anything is possible, exactly the way you want it. Be inspired by the Hörmann variety on the following pages or configure your dream door conveniently online.





**CONVINCING IN EVERY VERSION.** Our steel / aluminium entrance doors are available in various styles and with optional embellishments. As of 01.03.2024, the Thermo65 will also be available as a double-leaf entrance door to increase the clear passage width for pushchairs, wheelchairs, etc. The double-leaf entrance door has a flush-fitting transition from the traffic leaf to the fixed leaf and offers highly effective thermal insulation with a  $U_D$ -value of up to approx.  $1.1 \text{ W}/(\text{m}^2 \text{ K})$ .

**THE DOOR OF YOUR CHOICE IN JUST A FEW CLICKS.** With the door configurator, you can conveniently test many design and product variations on your own PC or tablet in advance. You can put your dream entrance door together in just a few clicks by selecting the door version, style, colour and size and also see the recommended retail price of your configuration. If you then upload a picture of your house and place the door in your entrance, you can see in advance how well your new entrance door will match your home.



The Hörmann configurator can be found at:  
[www.hormann.co.uk/uk/home-owners-and-renovators/configurator](http://www.hormann.co.uk/uk/home-owners-and-renovators/configurator)





# Thermo65



**RC2 security**  
Optional



**High thermal insulation**  
 $U_D$ -value of up to  $0.87 \text{ W}/(\text{m}^2\cdot\text{K})$

## THE PERFECT ENTRANCE TO YOUR HOME.

Choose from modern and classic styles, with and without glazing to find the entrance door that best suits your home. Door style 610S with frameless glazing impresses with a very elegant, sophisticated door view with maximum transparency.

The interior and exterior of Thermo65 doors are generally delivered with a matching appearance. Optionally, you can order Thermo65 entrance doors in Traffic white RAL 9016 on the inside to perfectly match your white residential internal doors!

The inside of the entrance door in Traffic white RAL 9016 goes perfectly with white residential internal doors (shown with optional SmartKey)



LEFT. Steel / aluminium entrance door Thermo65 style 610S, stainless steel handle HB 38-2, Satinato glazing, Basalt grey RAL 7012, optional side element



**Style 010**  
With embellishment view 751



**Style 010**



**Style 015**  
With embellishment view 400



**Style 015**



**Style 610S**



**NEW. Style 630S**



**Style 700B**



**Style 730B**

## THERMO65

All door styles on this double-page spread in Matt deluxe CH 703 Anthracite Metallic

**Style 010** stainless steel embellishment view 751 (optional), stainless steel handle HB 14-2

**Style 010** stainless steel handle HB 14-2

**Style 015** embellishment view 400 in stainless steel look (optional), stainless steel handle HB 14-2

**Style 015** stainless steel handle HB 14-2

**Style 515** stainless steel handle HB 14-2

**Style 610S** stainless steel handle HB 38-2, Satinato glazing

**Style 630S** stainless steel handle HB 38-2, Satinato glazing

**Style 700B** stainless steel handle HB 38-2 and stainless steel glazing frame, black.edition Jet black RAL 9005 (optional), sand-blasted glazing with 7 clear stripes

**Style 730B** stainless steel handle HB 38-2, sand-blasted glazing with 7 clear stripes

**Style 750C** stainless steel handle HB 38-2, sand-blasted glazing with 5 clear stripes

**Style 610S** as double-leaf entrance door, stainless steel handle HB 38-2, Satinato glazing

→ You will find all colours and surface finishes from page 34.





**Style 515**



TOP. Steel / aluminium entrance door Thermo65 style 700B, stainless steel handle HB 38-2, sand-blasted glazing with 7 clear stripes, Matt deluxe CH 703 Anthracite Metallic, optional side element; L-ribbed sectional garage door, Planar, Matt deluxe CH 703 Anthracite Metallic



**Style 750C**



**Style 610S**  
**NEW from March 2024.**  
 Double-leaf entrance door available for all Thermo65 styles\*

**MATCHING ENTRANCE AND GARAGE DOORS.** Harmonising garage and entrance doors give your home a special something. All entrance doors are available in the Hörmann colour Matt deluxe, matching the Hörmann sectional garage doors with L-ribbing and Planar surface finish. Or choose from the 10 MatchColor preferred colours and design your entrance door, sectional garage door, side door and steel door in a matching colour. Enjoy this coordinated look for a lifetime.

\* Except styles 100, 410S, 430E



Style 800S



Style 810E



Style 820S



Style 830S



Style 840S



Style 850B



Style 900D

## THERMO65

All door styles on this page in Grey aluminium RAL 9007

**Style 800S** stainless steel handle HB 38-2, Satinato glazing

**Style 810E** stainless steel handle HB 38-2, sand-blasted glazing with clear stripes (square)

**Style 820S** stainless steel handle HB 38-2, Satinato glazing

**Style 830S** stainless steel handle HB 38-2, Satinato glazing

**Style 840S** stainless steel handle HB 38-2, Satinato glazing

**Style 850B** stainless steel handle HB 38-2, sand-blasted glazing with 7 clear stripes

**Style 900D** stainless steel handle HB 38-2, sand-blasted glazing with 4 clear stripes, side elements with sand-blasted glazing with 4 clear stripes

→ You will find all colours and surface finishes from page 34.



TOP. Steel / aluminium entrance door Thermo65 style 100, stainless steel handle HB 14-2, Terra brown RAL 8028, optional side elements, S-panelled sectional garage door, Woodgrain, Terra brown RAL 8028



Style 100



Style 410S



Style 430E

## THERMO65

All door styles on this page in Terra brown, RAL 8028

**Style 100** stainless steel handle HB 14-2, side elements with Satinato glazing

**Style 410S** stainless steel handle HB 14-2, Satinato glazing

**Style 430E** stainless steel handle HB 14-2, sand-blasted glazing with clear stripes (frame)

→ You will find all colours and surface finishes from page 34.

**CUSTOM ENTRANCES.** Create stylish, attractive entrances and fill your home with more light. Each door style shown can be combined with side elements and transom lights. Special door versions are also possible, such as doors opening outwards. At Hörmann, you are sure to find the entrance door to suit your home.



TOP. Steel / aluminium entrance door Thermo65 style 010, stainless steel handle HB 38-2, Decograin Golden Oak, optional side elements

LEFT. Steel / aluminium entrance door Thermo65 style 010, stainless steel handle HB 14-2, Anthracite grey RAL 7016, optional side elements, opening outwards



**PERSONAL DESIGN.** You can custom-equip each of the entrance door styles. You want a special external handle or glazing? We offer all the options you need to give your entrance door a personal touch. When choosing a colour for your new Hörmann entrance door, we let your creativity run wild. Your options include soft matt MatchColor and Color preferred colours, elegant Matt deluxe colours or authentic, natural Decograin decors. The interior and exterior are generally the same colour. Optionally, you can order the Thermo65 in Traffic white RAL 9016 on the inside to match your white residential internal doors.

**RADIO DOOR LOCK OPERATOR SMARTKEY.** Easily open your door lock at the press of a button with your hand transmitter, radio internal push button or directly via the sensor field on the SmartKey. No need to set down your groceries in order to open your entrance door. Even with a walker, wheelchair or pram, it is much easier to enter your house, because you can open the door from a distance. Locking takes place either by pressing a button or automatically after a specified period of time. This securely locks your door and provides protection against break-ins.

→ For further information, see from page 40.



TOP RIGHT. Smart Home control centre Hörmann homee for all areas of your home

BOTTOM RIGHT. Convenient door opening with a smartphone

BOTTOM. Radio door lock operator SmartKey for simple door locking and release



**OPERATING COMFORT FOR YOUNG AND OLD.** Open your entrance door easily and conveniently with our smart solutions. By code, fingerprint, hand transmitter or smartphone. With our lock packages, you are sure to find an intelligent solution that meets your needs. With the Hörmann homee Smart Home control centre, you can conveniently control your Hörmann garage and entrance door, as well as climatic sensors or a camera all with an app. At any time of day or night, from anywhere around the world.

→ For further information, see from page 40.



HORNBAUM



# Thermo46



**RC2 security**  
Optional



**Good thermal insulation**  
 $U_D$ -value of up to  $1.1 \text{ W/(m}^2\cdot\text{k)}$

## IDEAL FOR YOUR SIDE ENTRANCE.

Steel / aluminium entrance door Thermo46 is the right choice for a side door for your home. Combined with a residential internal door as a vestibule, you can also use the Thermo46 in your entrance. We offer our entrance doors in many styles, from classic to modern, with or without glazing.

As standard, the Thermo46 doors are delivered with the same interior and exterior, that is the colour and surface on the outside and inside match.

Thermo46 doors offer you everything you expect from an excellent entrance door. Select a style to match your home!

LEFT. Steel / aluminium entrance door  
Thermo46 style 700B, stainless steel  
handle HB 38-2, Traffic white  
RAL 9016, optional side element



Style 010



Style 515



Style 700B



Style 750C



Style 015



Style 025S



Style 020S



Style 030S

## THERMO46

All door styles in the top row in Anthracite grey RAL 7016. All door styles in the bottom row in Traffic white RAL 9016.

**Style 010** stainless steel handle HB 14-2

**Style 515** embellishment view 400 in stainless steel look (optional), stainless steel handle HB 14-2

**Style 700B** stainless steel handle HB 38-2, sand-blasted glazing with 7 clear stripes

**Style 750C** stainless steel handle HB 38-2, sand-blasted glazing with 5 clear stripes

**Style 015** stainless steel handle HB 14-2

**Style 025S** with embellishment view 400 in stainless steel look (optional), stainless steel handle HB 14-2, Satinato glazing

**Style 020S** stainless steel handle HB 14-2, Satinato glazing

**Style 030S** stainless steel handle HB 14-2, Satinato glazing

→ You will find all colours and surface finishes from page 34.



**Style 900D**



TOP. Steel / aluminium entrance door Thermo46 style 400I, stainless steel handle HB 14-2, cathedral glass glazing, Traffic white RAL 9016, optional side elements



**Style 100**



**Style 200I**



**Style 400I**

## **THERMO46**

The door style in the top row in Anthracite grey RAL 7016. All door styles in the bottom row in Traffic white RAL 9016

**Style 900D** stainless steel handle HB 38-2, sand-blasted glazing with 4 clear stripes

**Style 100** stainless steel handle HB 14-2

**Style 200I** stainless steel handle HB 14-2, cathedral glass glazing

**Style 400I** stainless steel handle HB 14-2, cathedral glass glazing

→ You will find all colours and surface finishes from page 34.



30



38



40



# Design. Equipment. Accessories.

- 30 Door versions
- 32 Door equipment
- 34 Preferred colours, colours and decors
- 37 Customisation
- 38 Frames and glazings
- 39 Exterior handles and lever handle sets
- 40 Automatic locks and electric extras
- 42 Dimensions and fitting data

# Door versions

The right profile for any requirement

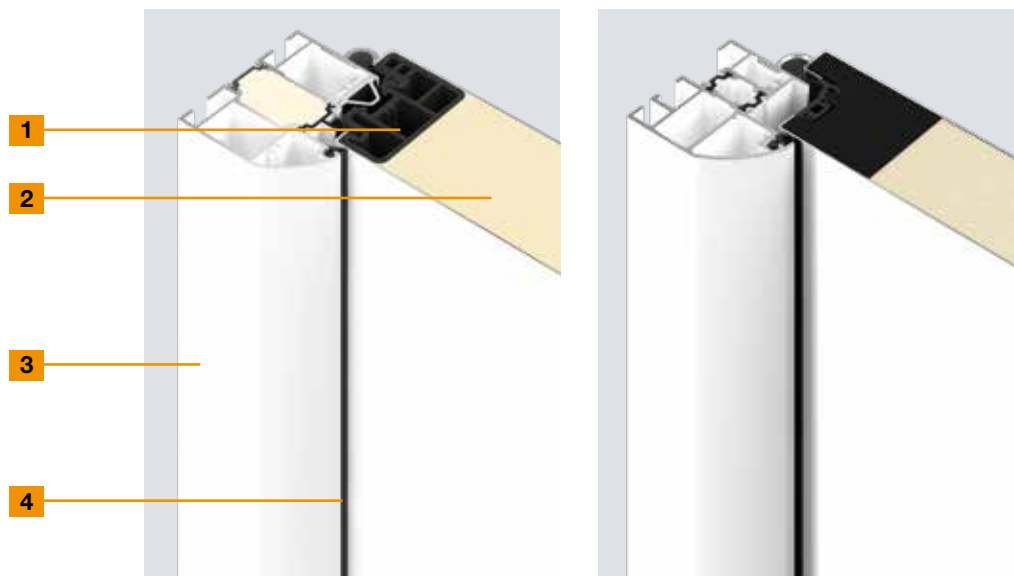

	Thermo65	Thermo46
<b>1</b> Door profile	Interior	Interior
Material	Compound material	Compound material
<b>2</b> Door leaf thickness	<b>65 mm</b>	<b>46 mm</b>
Internal and external sheet	Steel, with thermal break.	Steel, with thermal break.
<b>3</b> Door frame	Rounded frame A3, 80 mm	Rounded frame A1, 60 mm
Material	Aluminium, with thermal break	Aluminium, with thermal break
<b>4</b> Sealing system	<b>3 x</b>	<b>2 x</b>
Threshold	Aluminium / plastic (standard, S11), plastic (optional, S12)	Aluminium / plastic
Performance characteristics		
Operating forces EN 12217	Up to class 3	Up to class 2
Long-term functionality / mechanical load EN 12400	Up to class 6	Up to class 5
Differential climate behaviour EN 12219	Up to 2d / 2e	Up to 3c / 2d / 2e
Air permeability EN 12207	Up to class 4	Up to class 2
Water tightness under heavy rain EN 12208	Up to class 3A	Up to class 1A
Resistance to wind load EN 12210	Up to class C3 / B3	Up to class C3
Impact resistance EN 13049	Up to class 1	Up to class 1
Mechanical strength EN 1192	Up to class 3	Up to class 1
Thermal insulation	<b>Up to 0.87 W/(m<sup>2</sup>·K)</b>	<b>Up to 1.1 W/(m<sup>2</sup>·K)</b>
Acoustic insulation	Up to 42 dB	Up to 32 dB
Burglar protection EN 1627 (optional)	RC2 (optional)	RC2 (optional)

### Frame variants

Entrance doors Thermo65 and Thermo46 are optionally also available with an angular frame at no surcharge.

- 5** Thermo65 frame A4
- 6** Thermo46 frame A2

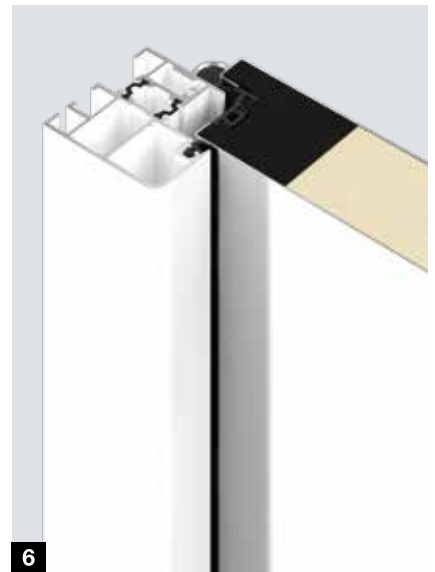

**RC2 security**  
Tested and certified

### Security doors

The opportunist burglar attempts to break open the locked door with simple tools within 3 minutes.



**Acoustic-rated**  
Up to 42 dB

### Acoustic-rated doors

You can use Thermo65 styles 010, 610S and 610N as acoustic-rated doors. With the standard threshold, the doors achieve acoustic rating category 3 (42 dB) and acoustic rating category 2 (37 dB) with the optional retractable bottom seal. They provide protection against street noise as well as wind and weather: the ideal solution – not only for entrance doors in blocks of flats with walkways.



**Fire-retarding**  
EI<sub>2</sub>30

### Fire-rated doors

The fire-rated door Thermo65 styles FSTHP 010 and FSTHP 610 withstand a fire for at least 30 minutes, making them the ideal solution for between the garage and your living space (e.g. entrance hallway). They also offer good thermal insulation for this sensitive area.

**Only from Hörmann**  
Acoustic-rated doors with thermal break

**Only from Hörmann**  
Fire-rated doors with thermal break

# Door equipment

For an elegant, functional door design



Thermo65

Thermo46

	Thermo65	Thermo46
<b>1</b> Solid door view from the inside	●	●
<b>2</b> 5-point security lock	●	●
<b>3</b> Soft-lock latch	●	●
Automatic lock with mechanical self-locking	○	
<b>4</b> Continuous security strip made of aluminium	●	
<b>5</b> 3 security bolts		●
<b>6</b> 3-way adjustable guide rollers	●	●
<b>7</b> Stainless steel interior lever	●	●
<b>8</b> Security push-on rose escutcheon	●	○
<b>9</b> Profile cylinder with emergency and hazard function and 5 locks as standard	●	●
<b>10</b> Letter plate in silver or gold		○*
<b>11</b> Spy Viewer		○*
<b>12</b> Door drip	○	○
<b>13</b> Retractable bottom seal	○	○

● = As standard ○ = Optional ○\* only for styles 100, 200, 400



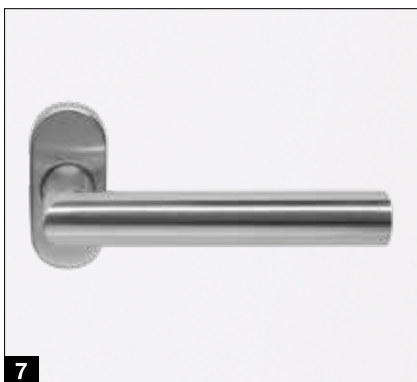
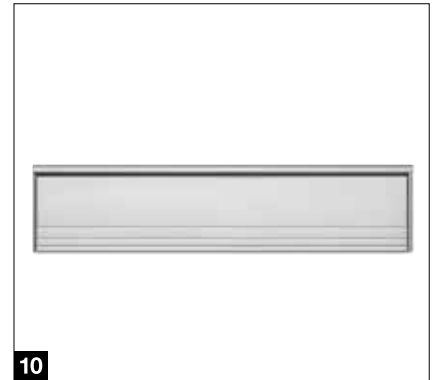

**12 Door drip**

(not shown)

Attractive protection: The door drip in White aluminium RAL 9006 or in stainless steel diverts driving rain and can also be easily retrofitted.

**13 Retractable bottom seal**

(not shown)

This optional equipment is the best solution for sealing entrance doors without threshold rail used for barrier-free entrances.

**Safe glazing.**

When it comes to industrial safety and burglar protection, Hörmann entrance doors fulfil the absolute highest demands. The safety glass on the interior and exterior of the insulated glazing provides maximum security. In case of glass breakage, the glass splinters are also bound on the inside, virtually eliminating any danger of being injured by the shards. Furthermore, the laminated safety glass offers better burglar protection as it makes reaching through more difficult.

# Preferred colours

MatchColor, Color



## MatchColor

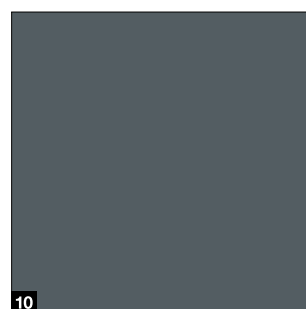
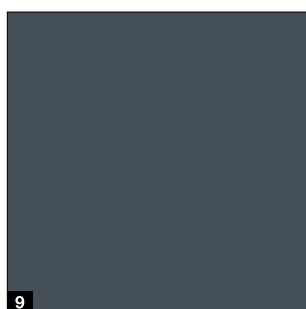
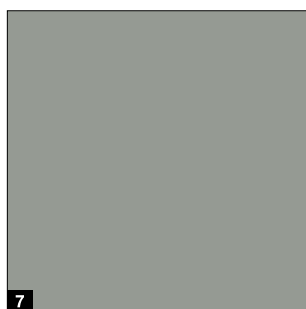
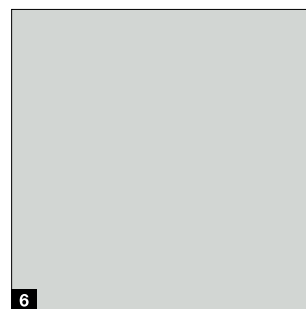
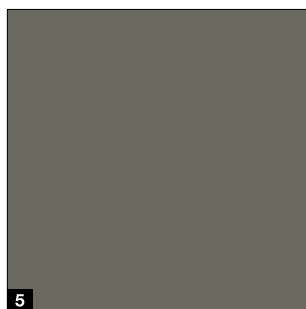
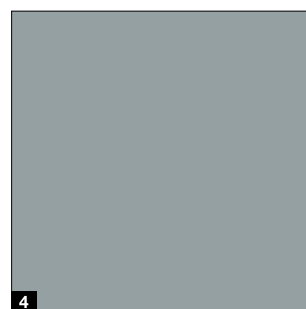
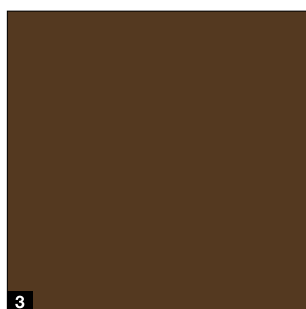
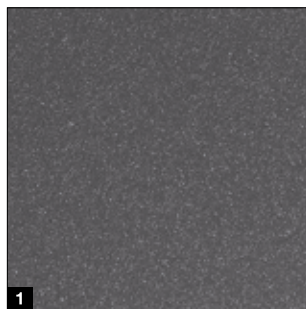

MatchColor

### MatchColor

Design your home in perfect colour harmony – with the MatchColor preferred colours for sectional garage doors, entrance doors, side doors and sheet steel doors with a matching appearance. Enjoy the harmonious overall appearance thanks to matching colours. That is Hörmann brand quality!

## Color

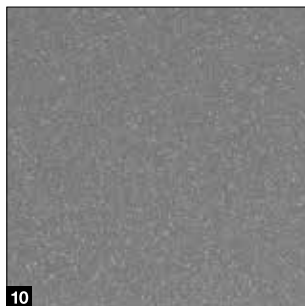
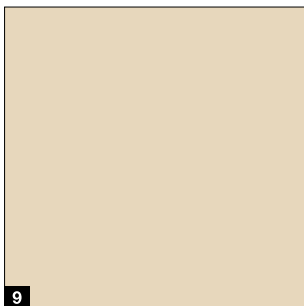
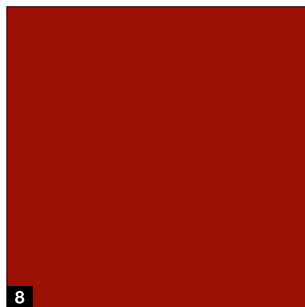
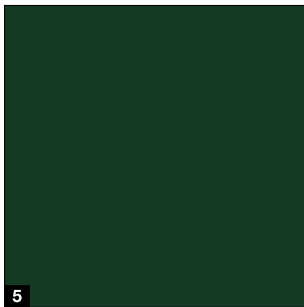
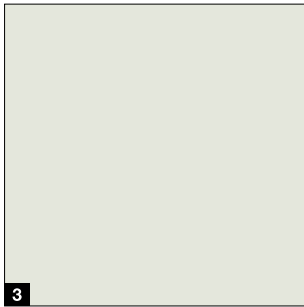
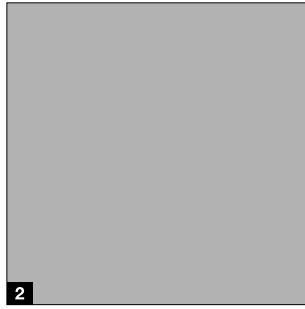
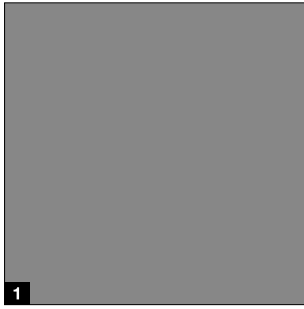

### MatchColor

- 1** CH 703 Anthracite metallic
- 2** RAL 9005 Jet black
- 3** RAL 8028 Terra brown
- 4** RAL 7040 Window grey
- 5** RAL 7039 Quartz grey
- 6** RAL 7035 Light grey
- 7** RAL 7030 Stone grey
- 8** RAL 7016 Anthracite grey
- 9** RAL 7015 Slate grey
- 10** RAL 7012 Basalt grey

### Color

- 1** RAL 9007 Grey aluminium
- 2** RAL 9006 White aluminium
- 3** RAL 9002 Grey white
- 4** RAL 7037 Dusty grey
- 5** RAL 6009 Fir green
- 6** RAL 6005 Moss green
- 7** RAL 5010 Gentian blue
- 8** RAL 3003 Ruby red
- 9** RAL 1015 Light ivory
- 10** CH 907 Grey aluminium

### Please note:

All colours based on RAL. The colours and surface finishes shown are subject to the limitations of the printing process and cannot be regarded as binding. **Please consult with your local Hörmann specialised dealer.**

# Other colours and decors

Matt deluxe colours and Decograin decors

## Matt deluxe

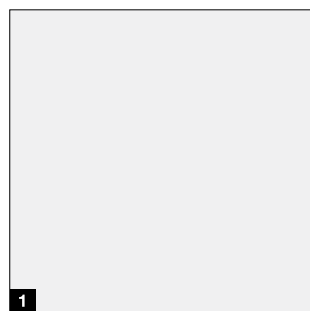

1

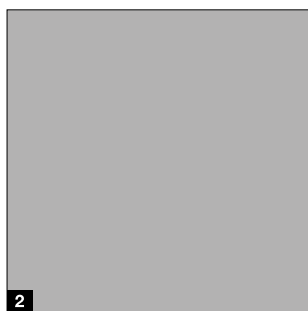

2

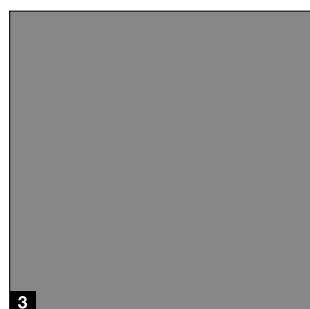

3

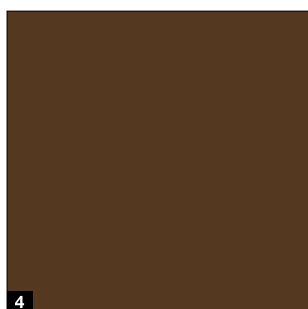

4



5

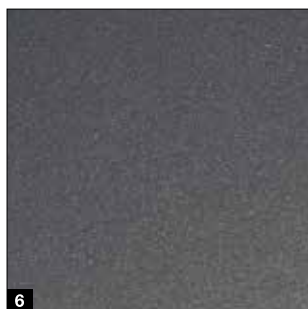

6



7

- 1 CH 9016 Matt deluxe Traffic white
- 2 CH 9006 Matt deluxe White aluminium
- 3 CH 9007 Matt deluxe Grey aluminium
- 4 CH 8028 Matt deluxe Terra brown
- 5 CH 7016 Matt deluxe Anthracite grey
- 6 CH 703 Matt deluxe Anthracite Metallic
- 7 CH 905 **NEW.** Matt deluxe black

## Decograin decors\*



1



2

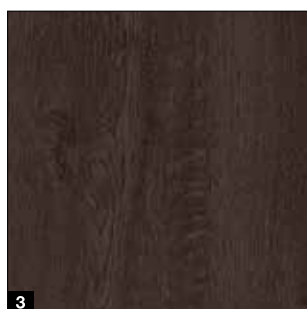

3



4

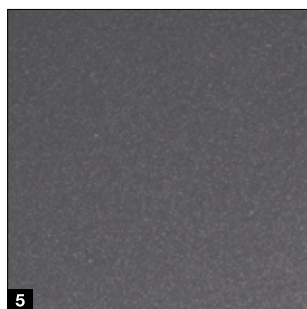

5

- 1 Golden Oak: medium brown, golden yellow oak decor
- 2 Dark Oak: walnut-coloured oak decor
- 3 Night Oak: dark, intense oak design
- 4 Winchester Oak: natural-coloured knotty oak decor
- 5 Titan Metallic CH 703: Anthracite with a metallic effect

**Please note:** The colours and surface finishes shown are subject to the limitations of the printing process and cannot be regarded as binding. Dark colours should not be used for doors that are exposed to the sun, as an increased material expansion may impair the door's function. **Please consult with your local Hörmann specialised dealer.**

\* Not available for Thermo65/46 styles 100, 200, 400, 410 and 430.

# Customisation

Design your entrance door to fit your needs

## Embellishments



Style 015, view 400



Style 515, view 401



Style 025, view 402



Style 015, view 403



Style 010, view 451



Style 010, view 454



Style 010, view 457



Style 010, view 459



Style 010, view 750



Style 010, view 751

## Door leaf and frame in different colours

Give your entrance door an individual look and combine the door leaf and frame in different colours for Thermo65 and Thermo46 entrance doors.



Frame in White aluminium RAL 9006, door leaf in Titan Metallic CH 703



Frame in Titan Metallic CH 703, door leaf in Traffic white RAL 9016

## Two-colour entrance doors and side elements

Entrance door Thermo65\* is available in the colours Anthracite RAL 7016 and CH 907 Grey aluminium, as well as surface finishes Decograin Golden Oak, Dark Oak and Titan Metallic CH 703, and in Traffic white RAL 9016 on the inside to perfectly match your white residential internal doors.



Viewed from outside in Decograin surface



Viewed from inside in Traffic white RAL 9016\*

\* Not available for Thermo65 styles 100, 410, 430, 610.

# Frames and glazings

For more light in your home

## Glazing frame for doors

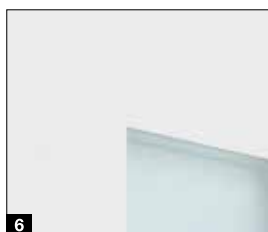

- 1 Stainless steel glazing frame**  
With virtually flush-fitting appearance on the inside and outside with triple-pane insulated glazing: Thermo65 style 700 / 730 / 750 / 780 / 800 / 810 / 820 / 830 / 840 / 850 / 900 as well as Thermo46 style 700 / 750 / 900
- 2 Stainless steel glazing frame black.edition**  
With elegant look in Jet black RAL 9005 with triple-pane insulated glazing: Thermo65 style 700 / 730
- 3 Synthetic glazing frame "Roundstyle"**  
For a modern, harmonious overall appearance. In a colour complementing the surface finish with Decograin surfaces. With double-pane insulated glazing: Thermo46 style 020 / 025 / 030 / 040
- 4 Synthetic glazing frame "Profilstyle"**  
Perfectly matching the panelled door styles with triple-pane insulated glazing: Thermo65 style 410 / 430 with double-pane cathedral insulated glazing: Thermo46 style 200 / 400
- 5 Frameless**  
Sophisticated appearance without glazing frame, with triple-pane insulated glazing: Thermo65 style 610S

## Glazings for doors, side elements and transom lights

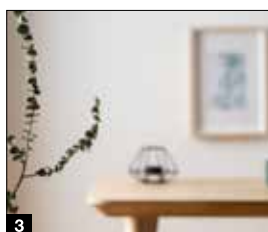
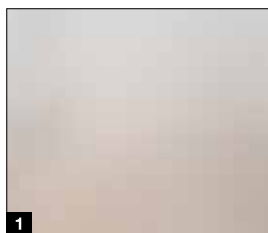

- 1 Satinato**
- 2 Sand-blasted / sand-blasted with clear stripes**
- 3 Clear glass**
- 4 Cathedral small hammered finish (only Thermo46)**
- 5 One-way plate glass**  
With reflection on the light side and the ability to see through the dark side to the light side (Thermo65 selected styles only)

# Exterior handles and lever handle sets

A beautiful handle accents the door

## Exterior handles



HB 14-2, brushed stainless steel

HB 38-2, brushed stainless steel

HB 38-2, black.edition, stainless steel Jet black RAL 9005 (for Thermo65)

HB 38-3, brushed stainless steel

HB 738, brushed stainless steel (for Thermo65)

**NEW.** HB 738, black.edition Stainless steel Jet black RAL 9005 (for Thermo65)

**NEW.** HB 739 Brushed stainless steel (for Thermo65 010, 700, 750, 800)

## Lever handle sets for outside and inside



Stainless steel lever handle set Type D-110



Lever handle set black.edition in Jet black RAL 9005 type D-110 (for Thermo65)



Stainless steel lever/knob handle set With knob type K-160, lever handle D-110



**NEW.** Lever / knob handle set black.edition in Jet black RAL 9005 with knob type K-160, lever handle D-110



Stainless steel lever handle set Type K-210



Stainless steel lever handle set Type D-310



Stainless steel lever handle set Type D-510



ES 0 / ES 1 lever/knob handle set with knob (shown: ES 1 in stainless steel)



Lever handle set ES 0 / ES 1 (ES 0 in stainless steel shown)

# Automatic locks and electric extras

Smart security

## Automatic lock with mechanical self-locking

(for Thermo65)

When the door falls shut, the bolts automatically extend and securely lock the entrance door.

## Automatic lock with electric motor and opening via BiSecur radio (for Thermo65)

Open your entrance door easily and conveniently via a hand transmitter, code switch or finger-scan. There's no longer any danger of forgetting your keys. The lock automatically locks the door when the door is closed.

- Hand transmitter HSE 4 BS, textured surface black with plastic caps
- Radio code switch FCT 3-1 BS
- Radio finger-scan FFL 25 BS
- Finger-scan integrated in the door leaf

## Automatic lock with electric motor and opening via Bluetooth (for Thermo65)

Opening your door via Bluetooth using your smartphone is even more convenient with the user-friendly Hörmann BlueSecur app. When closing the door, the lock automatically locks the door. You can optionally combine this equipment with an integrated finger-scan.

## Electric strike (for Thermo65 and Thermo46, not shown)

With the electric strike catch, you can conveniently open your door via a switch inside the house.

## Reed contact / latch switching contact

(for Thermo65 and Thermo46, not shown)

For connection to the building services or alarm system and evaluation that the door is closed (reed contact) or locked (latch switching contact).

## Radio door lock operator SmartKey

(for Thermo65 / Thermo46)

Easily open your door lock at the press of a button with your hand transmitter, radio internal push button or directly via the sensor field on the SmartKey. The automatic comfort lock ensures reliable and secure door locking. With the optional hand transmitter HS 5 BS or radio internal push button FIT 5, you can conveniently query whether the door is locked or unlocked – you no longer have to go to the door in the evening to check.

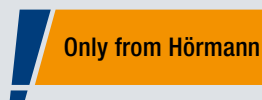

The automatic lock with electric motor and BiSecur radio system allows you to conveniently open your entrance door via a hand transmitter, radio code switch or radio finger-scan.

Another advantage is that you can use the same hand transmitter to operate your Hörmann garage door or entrance gate. The extremely secure radio system ensures that no unauthorised person can copy your radio signal. All operators, receivers and control elements with the BiSecur radio system are 100% compatible with each other.



Further information can be found in the "Door operators and Smart Home systems" brochure.





**Hand transmitter HSE 4 BS**  
4 button functions, incl. eyelet for key ring, textured surface Matt black with plastic caps



**Radio code switch FCT 3 BS**  
For 3 functions, with illuminated buttons, recessed and surface-mounted fitting possible, plastic housing in Light grey RAL 7040



**Radio finger-scan FFL 25 BS**  
For 2 functions and up to 25 fingerprints with hinged cover, recessed and surface-mounted fitting possible, plastic housing painted in White aluminium RAL 9006



**Finger-scan integrated in the door leaf**  
Fitting on the door leaf, for up to 150 fingerprints, VDS-approved, dimensions: 45 x 75 mm, optional for all automatic locks with electric motor

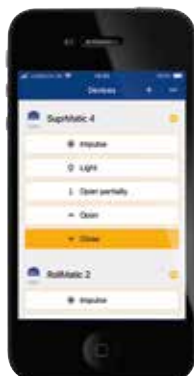

**Bluetooth receiver**  
For operation by smartphone using the Hörmann BlueSecur app



**Radio door lock operator SmartKey**  
Available in white or silver, incl. hand transmitter HSE 4 SK BS with labelled buttons



## Hörmann BlueSecur

**Only from Hörmann**  
European patent

Conveniently open and close your door via Bluetooth using your smartphone. Lock and unlock your entrance door using the user-friendly Hörmann BlueSecur app. In addition, other user permissions can be permanently or temporarily transferred to other smartphones, so that every family member always has their "entrance door opener" with them.

# Dimensions and fitting data

Thermo65 / Thermo46

## Thermo65\* standard sizes

Overall frame dimension (ordering size)	Clear passage*
1,000 × 2,100	850 × 2,005
1,100 × 2,100	950 × 2,005

## Thermo46 standard European sizes

Overall frame dimension (ordering size)	Clear passage*
1,000 × 2,100	872 × 2,016
1,100 × 2,100	972 × 2,016

## Special sizes Thermo65 / Thermo46\*

Styles	Overall frame dimension (ordering size)
200	875 – 1,100 × 1,990 – 2,186
010, 020, 030, 700, 730, 750, 800, 810, 840	700 – 1,250 × 1,875 – 2,250
015, 025, 515, 780	875 – 1,250 × 1,875 – 2,250
100, 400, 410, 430	875 – 1,100 × 1,875 – 2,186
820, 830, 850, 900	800 – 1,250 × 1,875 – 2,250
610	875 – 1,250 × 2,000 – 2,250

\* For double-leaf entrance doors, the traffic leaf is ordered as a standard size, the fixed leaf is always a special size.

## Horizontal view of door, Thermo65

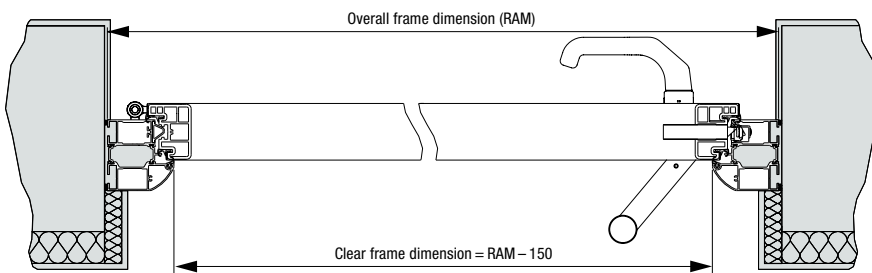

## Vertical view of door, Thermo65

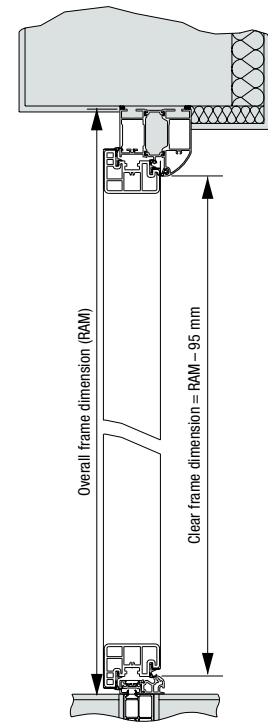

## Horizontal view of side element, Thermo65

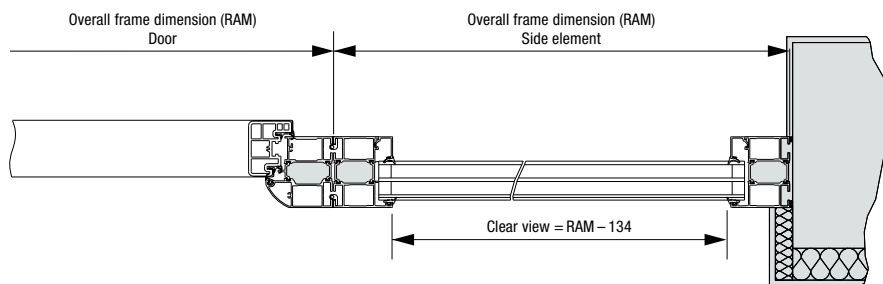

## Frame variants, Thermo65

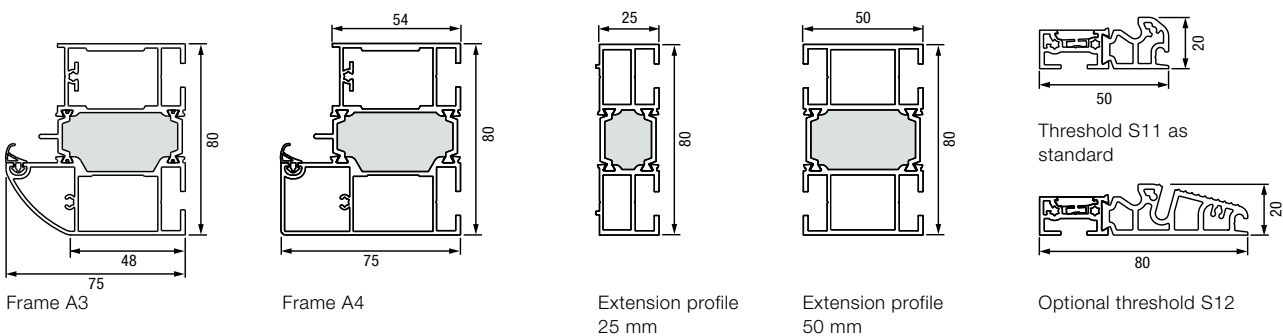

### Side element standard sizes

Version	Overall frame dimension (ordering size)
Thermo65 / Thermo46	400 × 2,100 400 × 2,200

### Side element special sizes

Versions	Overall frame dimension (ordering size)
Thermo46 Thermo65	300 – 1,000 <sup>1</sup> × 700 – 2,250 300 – 1,000 <sup>1</sup> × 700 – 2,250

<sup>1</sup> Transom light not possible from a width of 500 mm. Door sets with side elements do not contribute to the static equilibrium, which must be guaranteed by the building structure.

### Transom light special sizes

Version	Overall frame dimension (ordering size)
Thermo65 / Thermo46	700 – 2,250 × 300 – 500

### Horizontal view of door, Thermo46

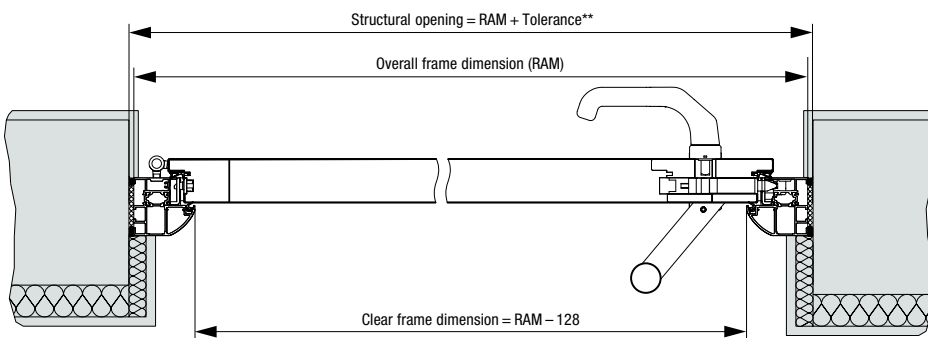

### Vertical view of door, Thermo46

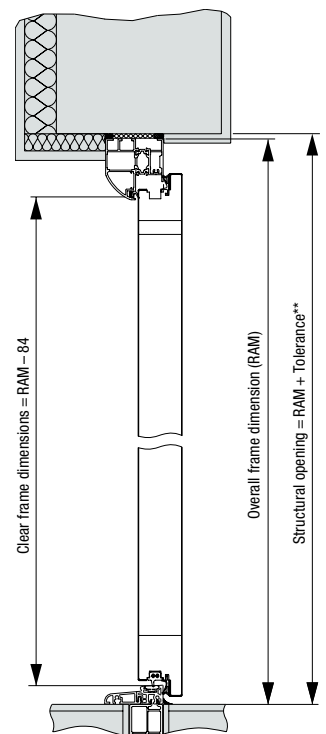

### Horizontal view of side element, Thermo46

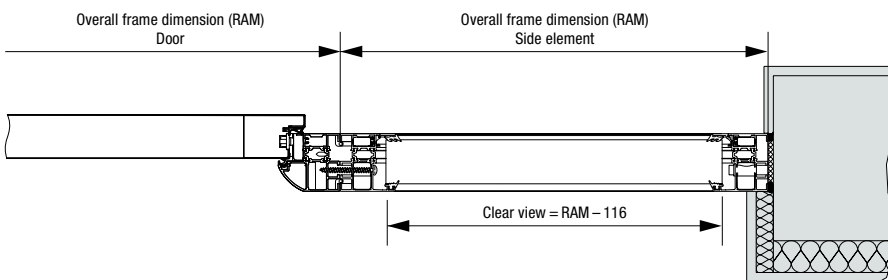

### Frame variants, Thermo46

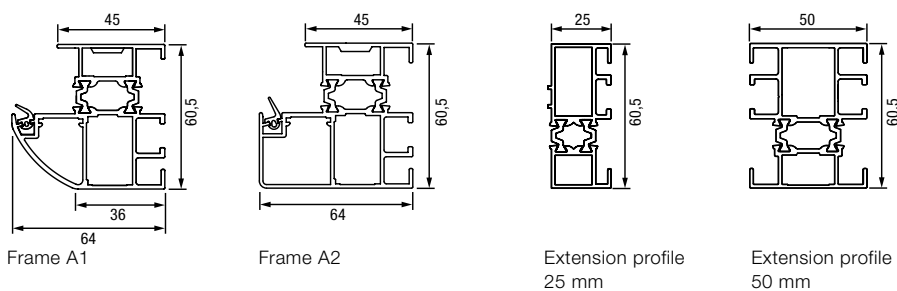

\*\* The structural opening height is based on the finished floor dimension which includes any and all floor coverings. (Please note that each application/project is unique and the tolerance may alter) These doors are rebated on all four sides, failure to take the floor covering into consideration could prevent the door from opening.

# Experience Hörmann quality in new construction and modernisation

Hörmann products have impressive durability and high functionality. You can easily plan for new construction as well as modernisation. The carefully coordinated solutions make your home more beautiful, more secure and more comfortable.

**GARAGE DOORS. GATE AND DOOR OPERATORS. ENTRANCE DOORS. RESIDENTIAL INTERNAL DOORS. STEEL DOORS. FRAMES. STORAGE SPACE SYSTEMS.**



Some of the products shown are equipped with special equipment and do not always correspond to the standard versions. The surface finishes and colours shown are subject to the limitations of the printing process and cannot be regarded as binding. All rights reserved. No part may be reproduced without our prior permission. Subject to changes.